



# *CIRCULAR SAWMILLS*

## *AND THEIR EFFICIENT OPERATION*



by Stanford J. Lunstrum

U.S. DEPARTMENT OF AGRICULTURE  
FOREST SERVICE  
STATE & PRIVATE FORESTRY

# **CIRCULAR SAWMILLS AND THEIR EFFICIENT OPERATION**

by

**Stanford J. Lunstrum  
Sawmill Specialist**

**USDA Forest Service  
State and Private Forestry  
Reprinted  
1993**

### **ABOUT THE AUTHOR**

Stanford J. Lunstrum received his B.S. degree in forestry from Iowa State University in 1962 and worked for a lumber company in Iowa from 1962 to 1964. From 1964 to 1967 he served as an instructor in sawmilling at the University of Kentucky Robinson Substation, Quicksand, Kentucky. From 1967 to 1972 he was a sawmill specialist for the Southeastern Area of State and Private Forestry, USDA Forest Service. He is currently with State & Private Forestry, stationed at the Forest Products Laboratory, Madison, Wisconsin.

## ACKNOWLEDGEMENTS

The author wishes to express special appreciation for the highly competent and constructive assistance of Mr. Hiram Hallock, technologist for the quality and yield improvement sector of timber utilization research at the U.S. Forest Products Laboratory, Madison, Wisconsin. Mr. Hallock gave freely of his time and expert advice to assure the highest possible accuracy of the manual, and also made helpful suggestions to make the technical explanations more readily understood. Others who rendered valuable assistance were:

Thomas P. Brogan  
Executive Vice President  
Northern Hardwood & Pine Manufacturers Association  
Green Bay, Wisconsin

William (Andy) Cloer  
Saw Filer Instructor  
Haywood Technical Institute  
Clyde, North Carolina

Edgar (Cliff) Cook  
Sawyer Instructor  
Haywood Technical Institute  
Clyde, North Carolina

Wilbur Doyle, Owner  
Doyle Lumber Company  
Martinsville, Virginia

A.G. Fegles  
General Superintendent  
West Coast Lumber Inspection Bureau  
Portland, Oregon

J. Hefferon, Manager  
R. Hoe & Company, Inc.  
New York, New York

E.E. Jones  
Director of Field Staff  
Southern Pine Inspection Bureau  
Pensacola, Florida

William James Kidd  
Executive Secretary  
Northeastern Lumber Manufacturers Association  
Glens Falls, New York

J.E. McKenzie  
Chairman of the NHLA Rules Committee  
Kimberly Clark Corporation  
Neeah, Wisconsin

M.B. Pendleton, Secretary-Manager  
National Hardwood Lumber Association  
Chicago, Illinois

Eugene J. Porter, Advertising Manager  
Simonds Saw & Steel Division  
Wallace-Murray Corporation  
Fitchburg, Massachusetts

James R. Pynes  
Chief Quality Supervisor  
Western Wood Products Association  
Portland, Oregon

W.W. Rowland  
Sawyer Instructor  
Haywood Technical Institute  
Clyde, North Carolina

E.A. Scott, President  
Southern Cypress Manufacturers  
Association  
Jacksonville, Florida

H.V. Shown, Regional Supervisor  
Division of Reliance Electric Co.  
Dodge Manufacturing Corporation  
Mishawaka, Indiana

George A. Thompson  
Building Standards Manager  
Redwood Inspection Service  
San Francisco, California

C.A. Wollmer  
Industrial Product Manager  
Disston Division  
H.K. Porter Company, Inc.  
Pittsburgh, Pennsylvania

George B. Wright  
Sawyer & Millright Instructor  
Haywood Technical Institute  
Clyde, North Carolina

Rollin H. Yale, Manager  
Lumber Processing  
Thomasville Furniture Industries  
Thomasville, North Carolina

The author is also indebted to the Haywood  
Technical Institute for making its sawmill facilities  
available for the photography necessary to illus-  
trate this manual.

The use of trade, firm, or corporation names in  
this publication is for the information and conven-  
ience of the reader. Such does not constitute an  
official endorsement or approval of any product  
or service by United States Department of Agri-  
culture to the exclusion of others which may be  
suitable.

## CONTENTS

|   | Page |
|---|------|
| INTRODUCTION . . . . .                        | iv   |
| ACCURATE SAWING OF LUMBER . . . . .           | 1    |
| EQUIPMENT SELECTION . . . . .                 | 11   |
| Headsaw . . . . .                             | 12   |
| Saw Arbor . . . . .                           | 17   |
| Saw Collars . . . . .                         | 19   |
| Pulleys and V-Belts . . . . .                 | 20   |
| Power . . . . .                               | 26   |
| Carriage and Tracks . . . . .                 | 32   |
| EQUIPMENT SET UP . . . . .                    | 37   |
| Mill Foundation . . . . .                     | 38   |
| Tracks . . . . .                              | 39   |
| Husk . . . . .                                | 42   |
| EQUIPMENT OPERATION AND MAINTENANCE . . . . . | 47   |
| Carriage and Saw Speed . . . . .              | 48   |
| Mill Foundation . . . . .                     | 51   |
| Headsaw . . . . .                             | 52   |
| Pulleys and V-Belts . . . . .                 | 61   |
| Saw Arbor . . . . .                           | 63   |
| Saw Collars . . . . .                         | 64   |
| Carriage and Tracks . . . . .                 | 66   |
| Guide for Troubleshooting . . . . .           | 71   |
| Checklist for Periodic Maintenance . . . . .  | 76   |
| BIBLIOGRAPHY . . . . .                        | 77   |
| SPECIFIC GRAVITY VALUES . . . . .             | 81   |
| STANDARD SAW GAGES . . . . .                  | 85   |

## INTRODUCTION

This manual was written for circular sawmill operators who recognize the need for producing the maximum yield of well manufactured lumber in the shortest possible time.. It does not attempt to cover all aspects of sawmill operation; it is concerned only with the first and most important step - primary sawing - and all the mechanical components that affect the primary sawing function.

Through the use of this manual, many circular sawmill operators can increase the efficiency of their sawing operation. Many operators could realize an increase of 10 percent or more in lumber output by improving the accuracy of their cutting. For example, an operator with a log input of 5 million board feet per year could realize an additional 500,000 board feet through improved efficiency. This means not only substantial savings in timber resources but also a lowering of per-unit cost and consequently higher profits for the operation.

But no quick cure-alls or shortcuts will bring about an efficient sawmill - it doesn't "just happen". Rather, it is brought about by the determination to correct deficiencies and insure that every piece of equipment related to sawing operates properly and functions smoothly together as a unit.

**ACCURATE SAWING  
OF  
LUMBER**





*Figure 1. – Excessively thick or thin lumber reflects inefficient mill operation and is a waste of sawtimber resources.*

One way to gage a mill's efficiency is to measure its ability to cut lumber consistently within specified thickness standards (fig. 1).

Two basic factors affect lumber sizing accuracy: (1) the mechanical capability of sawing within given tolerances and (2) the human capability of determining the correct setting.

#### **SAWING LUMBER WITHIN GIVEN TOLERANCES**

A sawmill must be in A-1 condition to cut lumber within close specified tolerances; a rundown mill is not likely to produce lumber to accepted standards of quality. Seldom understood is the fact that producing lumber within specified tolerances results in more footage from a given log input.

Reineke<sup>1</sup> outlines three ways in which lumber volume may be increased by cutting to narrower tolerances. The first is by adding to the thickness of a final board that may be somewhat scant in thickness. Scant lumber is usually rejected and, therefore, is lost to the size class for which it was cut. If, for example, a board is 1/4-inch scant, a saving of 1/16 inch on each of four boards is sufficient to make the last board a full-sized one instead of a reject.

<sup>1</sup>Reineke, L.H. 1966. Volume loss from inaccurate sawing. Forest Prod. Lab., U.S. Forest Serv. Res. Note 0111.

Secondly, in the second half of a log being sawed through and through, the accumulated reduction in thickness brings the last half of the boards nearer the center, thus increasing their widths (fig. 2). Some boards, especially in softwoods, may be scant in width, and the increase in width of the slightly thinner boards may be sufficient to place them in the next width class.

The third source of increased yield is the occasional increase in trimmed length of short outside boards. Such boards may be slightly scant in length, so that nearly 2 feet of length for softwoods, or nearly 1 foot for hardwoods, must be trimmed off. Any increase in width of the last board may not be sufficient to increase the edged width by one increment, but it may increase the length enough to place it in the next longer length class.

Certain log diameters will yield an additional board. For example, a log 12 inches in diameter may lack 1/2 inch of producing an extra board. A gain of 1/32 inch in six cuts, a total of 3/16 inch, will not provide enough additional thickness for another board and might fail to increase the edged width or trimmed length. However, for a log diameter of 12.4 inches, the 3/16-inch gain in thickness will provide the additional board and might also add enough wood to gain an extra inch in edged width or an extra 2 feet in trimmed length. It must be remembered that in no case is scale reduced by making improvements in the sizing of lumber. On the contrary, any such effort always results in some increase overall by any one or combinations of ways mentioned by Reineke.

Lumber must be sawn at a certain minimum green thickness that, when dry, will dress out to the thickness required. Lumber that does not dress out to the required dry thickness is rejected as scant. Such lumber must then be remanufactured into other products and because of these added costs scant lumber often becomes an unprofitable item.

No sawmill produces lumber consistently at a specified target set without some variation between boards. All mills must include a plus or minus tolerance around their target set to allow for this variation in lumber thickness. The amount of tolerance required for a given sawmill depends upon stress in the logs, condition of mill equipment, and the manner in which the mill is operated.

Table 1 lists thickness standards for lumber produced by circular headrigs under various grading rules. It is possible for a mill to cut at a lower target set than that recommended in this table but, in any case, it is important that lumber not be below the stipulated minimum green thickness. All possible size classes are not necessarily listed for each association.

It should be noted that associations dealing with softwood lumber permit one out of five boards in a shipment to be 1/32 inch thinner than the specified minimum rough dry thickness. The Southern Cypress Manufacturers Association allows one out of five boards in a shipment of standard yard boards to be 28/32 inch, minimum rough dry thickness; standard industrial boards must not be less than 30/32 inch but the association will allow 1 out of 10 boards to be 29/32 inch, minimum rough dry thickness.

But because an association allows a specified percentage of the boards to be cut under-thickness does not mean that a mill should strive to produce that many boards under-size. It should acquire the control to produce its lumber within as narrow tolerances as possible, with few or no boards falling below the stipulated minimum green thickness. This not only assures a well manufactured product that is highly saleable but also allows the maximum yield to be realized from the log input.

Table 1. – Thickness standards for lumber produced by circular headrigs under various grading rules

| Nominal  | Dry     |               | Green              |                        |                     |
|--|---------|---------------|--------------------|------------------------|---------------------|
|  | Dressed | Minimum rough | Stipulated minimum | Recommended target set | Recommended maximum |
| ----- 32nd inches -----                              |         |               |                    |                        |                     |
| <b>NATIONAL HARDWOOD LUMBER ASSOCIATION</b>          |         |               |                    |                        |                     |
| 3/4  | 18      | 24            | 25                 | 28                     | 31                  |
| 4/4  | 26      | 32            | 34                 | 37                     | 40                  |
| 5/4  | 34      | 40            | 43                 | 46                     | 49                  |
| 6/4  | 42      | 48            | 51                 | 54                     | 57                  |
| 7/4  | 48      | 56            | 59                 | 63                     | 67                  |
| 8/4  | 56      | 64            | 68                 | 72                     | 76                  |
| <b>SOUTHERN PINE INSPECTION BUREAU</b>               |         |               |                    |                        |                     |
| 4/4  | 24      | 28            | 29                 | 32                     | 35                  |
| 5/4  | 32      | 36            | 38                 | 41                     | 44                  |
| 6/4  | 40      | 44            | 47                 | 50                     | 53                  |
| 7/4  | 44      | 48            | 51                 | 55                     | 59                  |
| 8/4  | 48      | 52            | 56                 | 60                     | 64                  |
| 10/4   | 64      | 68            | 72                 | 76                     | 80                  |
| <b>SOUTHERN CYPRESS MANUFACTURERS ASSOCIATION</b>    |         |               |                    |                        |                     |
| 4/4  | 25      | 29            | 31                 | 34                     | 37                  |
| 5/4  | 34      | 38            | 41                 | 44                     | 47                  |
| 6/4  | 42      | 46            | 49                 | 52                     | 55                  |
| 7/4  | 46      | 50            | 53                 | 57                     | 61                  |
| 8/4  | 52      | 56            | 59                 | 63                     | 67                  |
| 10/4   | 68      | 72            | 76                 | 80                     | 84                  |
| <b>REDWOOD INSPECTION SERVICE</b>                    |         |               |                    |                        |                     |
| 4/4  | 24      | 28            | 29                 | 32                     | 35                  |
| 5/4  | 34      | 38            | 39                 | 42                     | 45                  |
|  | 42      | 46            | 47                 | 50                     | 53                  |
| 8/4  | 52      | 56            | 57                 | 61                     | 65                  |
| <b>WEST COAST LUMBER INSPECTION BUREAU</b>           |         |               |                    |                        |                     |
| 4/4  | 24      | 28            | 29                 | 32                     | 35                  |
| 5/4  | 32      | 36            | 38                 | 41                     | 44                  |
| 6/4  | 40      | 44            | 46                 | 49                     | 52                  |
| 8/4  | 48      | 52            | 55                 | 59                     | 63                  |
| 10/4   | 64      | 68            | 71                 | 75                     | 79                  |
| <b>WESTERN WOOD PRODUCTS ASSOCIATION<sup>1</sup></b> |         |               |                    |                        |                     |
| 4/4  | 24 (24) | 28 (28)       | 30 (29)            | 32 (32)                | 34 (35)             |
| 5/4  | 37 (32) | 41 (36)       | 43 (38)            | 46 (41)                | 49 (44)             |
| 6/4  | 45 (40) | 49 (44)       | 51 (46)            | 54 (49)                | 57 (52)             |
| 7/4  | 51 (44) | 55 (48)       | 58 (51)            | 61 (55)                | 64 (59)             |
| 8/4  | 58 (48) | 62 (52)       | 65 (55)            | 68 (59)                | 71 (63)             |
| 9/4  | 67      | 71            | 74                 | 78                     | 82                  |
| 10/4   | 76 (64) | 80 (68)       | 83 (71)            | 86 (75)                | 89 (79)             |

Table continued on following page

**NORTHEASTERN LUMBER MANUFACTURERS ASSOCIATION**

|      |    |    |    |    |    |
|------|----|----|----|----|----|
| 4/4  | 24 | 28 | 29 | 32 | 35 |
| 5/4  | 32 | 36 | 38 | 41 | 44 |
| 6/4  | 40 | 44 | 46 | 49 | 52 |
| 8/4  | 48 | 52 | 55 | 59 | 63 |
| 10/4 | 64 | 68 | 71 | 75 | 79 |

**NORTHERN HARDWOOD AND PINE MANUFACTURERS ASSOCIATION**<sup>1 2</sup>

|      |         |         |         |         |         |
|------|---------|---------|---------|---------|---------|
| 4/4  | 24 (24) | 28 (28) | 30 (29) | 33 (32) | 36 (35) |
| 5/4  | 37 (32) | 41 (36) | 43 (38) | 46 (41) | 49 (44) |
| 6/4  | 45 (40) | 49 (44) | 51 (46) | 54 (49) | 57 (52) |
| 7/4  | 51 (44) | 55 (48) | 58 (51) | 62 (55) | 66 (59) |
| 8/4  | 58 (48) | 62 (52) | 65 (55) | 69 (59) | 73 (63) |
| 9/4  | 67      | 71      | 74      | 78      | 82      |
| 10/4 | 76 (64) | 80 (68) | 83 (71) | 87 (75) | 91 (79) |

<sup>1</sup>The first set of numbers is for cutting dry shop, selects, and common grades; the numbers in parentheses are for cutting dry finish boards and dry dimension.

<sup>2</sup>Four-quarter shop lumber must be dressed at 25/32 inch, which necessitates cutting it 1/32 inch thicker than recommended in the table.

**BOARD NO.    WIDTH (inches)**

|       |    |
|-------|----|
| 1     | 6  |
| 2     | 10 |
| 3     | 12 |
| 4     | 14 |
| 6     | 14 |
| 6     | 14 |
| 7     | 13 |
| 8     | 10 |
| 8     | 7  |
| <hr/> |    |
| 1     | 6  |
| 2     | 11 |
| 3     | 13 |
| 4     | 14 |
| 5     | 14 |
| 6     | 13 |
| 7     | 10 |
| 8     | 5  |

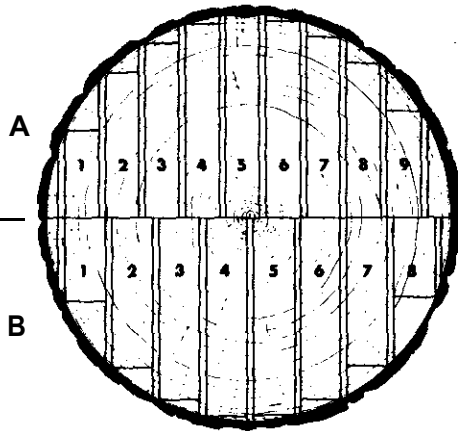

**Drawn to Scale**

*Figure 2. – In this 15-inch log, a difference in lumber yield is realized by cutting for a given thickness class at two different target sets, 40/32 inches in A and 48/32 inches in B. Saw kerf 1/4 inch in each case. Boards 6, 7, and 8 in A are sawn nearer the center of the cant increasing their widths and thus their footages over corresponding boards in B. Also, an extra board is realized in A. The total additional footage gained in A over B is about 16 percent.*

When cut under rules of the National Hardwood Lumber Association (NHLA), lumber produced from such high-shrinkage species as cottonwood, pecan, hickory, hard maple, beech, gum, and the oaks will generally dress out to the required dry, dressed thickness if cut at or above the stipulated minimum thickness recommended in table 1. However, 5/4 pecan, hickory, hard maple, beech, gum, and white oak should be cut with the stipulated minimum thickness 1/32 inch greater than that recommended in table 1. Eight-quarter pecan, hickory, beech, and white oak should be cut with the stipulated minimum thickness 1/16 inch greater than that recommended.

Low-shrinkage species such as yellow-poplar, cherry, soft maple, and butternut will generally dress out to the required dry dressed thickness if cut no more than 1/32 inch below the stipulated minimum thickness recommended in table 1. Eight-quarter cherry can be cut with the stipulated minimum thickness 1/16 inch less than that recommended.

The dry dressed and minimum rough dry figures in table 1 comply with the various lumber association grading specifications. The “green” figures are recommendations and therefore are subject to adjustment to suit specific needs. However, good results can generally be obtained by cutting lumber within the recommendations given. If possible, the operator and buyer should agree to minimum and maximum acceptable thicknesses.

The dry dressed thickness applies to lumber after it is dressed on both sides. The minimum rough dry thickness is that required after lumber has dried and before it has been planed. Green lumber, direct from the saw, must be no less than the stipulated minimum thickness so that when it shrinks it will not be below the minimum rough dry thickness. Lumber that is thinner than the stipulated minimum thickness will not dress out to the specified dry, dressed thickness. The recommended target set is the board thickness a sawyer should attempt to cut when sawing for a given thickness class and includes a sawing tolerance that allows for inherent thickness variation when producing lumber. The recommended maximum thickness is the upper limit on the plus side of the tolerance; the stipulated minimum thickness is the lower limit on the minus side of the tolerance. In general, boards that fall above the recommended maximum thickness represent a certain amount of wasted wood. Lumber produced between the stipulated minimum thickness and the recommended maximum thickness is acceptable.

Applying intensive quality control can mean taking numerous measurements on boards and making time-consuming calculations. While this may be required for research or other use, the average mill operator does not have the time nor is it necessary to make such detailed analyses. One of the simplest and quickest ways of checking thickness standards for lumber is to use a set of go-no-go gages. Their use for lumber quality control in the sawmill has been advocated for years.

A go-no-go gage can be constructed from any hard, durable metal, as shown in figure 3. The inner, narrower notch of the gage is determined by the stipulated minimum thickness for the size class desired, minus .005 inch. The outer, larger notch is determined by the recommended maximum thickness. Lumber that does not fit into the gage at all is too thick; lumber that fits into the inner notch is too thin. Only lumber that fits into the first notch is considered within acceptable limits. Dimensions for the notches can be determined from table 1 according to the species and the association rules under which the lumber is to be manufactured.

An efficient mill should produce at least 95 percent of its lumber within acceptable limits. To test a mill's capability of producing lumber within these limits, saw a sample of 100 boards and measure them for acceptability with a go-no-go-gage. Measure all boards sawn including the first board next to the slab cut and dog boards. Check the edge of each board for fit into the first notch only. If any part of a board does not comply, exclude it in the count of acceptable boards. Do not take readings on wany edges.

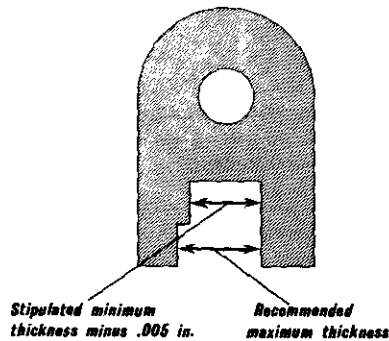

Figure 3. – A go-no-go gage is simple to construct. One-fourth-inch thick stainless steel is ideal for making such a gage.

If more than 5 of the 100 boards fall outside the acceptable limits, you should troubleshoot. Locate weak areas of mill maintenance or faulty operating practices and correct them as discussed in other sections of this manual.

### PRACTICING GOOD SETTING HABITS

Wood chips, bark, splinters, sawdust, or other material lodging between the knees or headblocks and cant can result in inaccurately sized lumber and should be kept from accumulating in these places. The problem may be that excessive amounts of this material are allowed to escape the intended point of collection. Shielding vulnerable areas from flying bark, sawdust, and other material may help to alleviate this problem. In persistent cases, a system of forced air may be necessary to keep troublesome spots free from such debris.

Mathematical miscalculation of settings and carelessness in making the set can lead to the same results as operating faulty equipment. Weekly checks of the scaleboard indicator should be made to determine the accuracy of the actual set. Temperature variations and equipment wear, as well as other causes, can affect setting accuracy.

The thickness of boards coming off the headsaw should be as near the recommended target set as possible. Precalculating settings helps to insure that all boards, including the dog board, are at the intended thickness. A sawyer needs to know the exact setting required for beginning his run to avoid taking a shim cut which wastes wood as well as time. This is particularly important when a flat face is against the knees and a sawyer intends to make his finish run from that setting. A sawyer eventually learns the settings to use at the beginning of his runs. But while he is learning he must figure these settings to fit the situation at hand and he may post them on the wall or on a card for quick reference.

Setting guides are generally tailor-made for each mill operation. Constructing a setting guide depends on the thickness class cut and the saw kerf used. With the exception of the dog board, scaleboard settings are derived by cumulatively adding the target set and the saw kerf of boards to be sawn. The dog board setting is simply the desired thickness of the dog board. Add to this the target set for the next board and the saw kerf to arrive at the next setting and so on for each

successive setting. Table 2 shows a setting guide for a mill sawing a single thickness class, and table 3 shows the same guide expanded for sawing two thickness classes from the same log.

Table 2. – Sample scaleboard settings for a mill sawing a single size class<sup>1</sup>

| No. of 4/4 pieces left in cant | Settings      |
|--------------------------------|---------------|
|                                | <b>Inches</b> |
| 1 (Dogboard)                   | 1             |
| 2                              | 2-9/32        |
| 3                              | 3-9/16        |
| 4                              | 4-27/32       |
| 5                              | 6-1/8         |
| 6                              | 7-13/32       |
| 7                              | 8-11/16       |
| 8                              | 9-31/32       |

<sup>1</sup> Mill sawing 4/4 lumber at a desired thickness of 32/32 inches (target set) and using a 9/32-inch saw kerf

Table 3. – Sample scaleboard setting for a mill sawing two thickness classes<sup>1</sup>

| No. of 4/4 pieces left in cant | No. of 8/4 pieces left in cant |                    |         |         |          |          |
|--------------------------------|--------------------------------|--------------------|---------|---------|----------|----------|
|                                | 0                              | 1                  | 2       | 3       | 4        | 5        |
|                                | ----- Inches -----             |                    |         |         |          |          |
| 0                              | XXX                            | <sup>2</sup> 1-718 | 4-1/32  | 6-3/16  | 8-11/32  | 10-1/2   |
| 1                              | <sup>2</sup> 1                 | 3-5/32             | 5-5/16  | 7-15/32 | 9-5/8    | 11-25/32 |
| 2                              | 2-9/32                         | 4-7/16             | 6-19/32 | 8-3/4   | 10-29/32 |          |
| 3                              | 3-9/16                         | 5-23/32            | 7-7/8   | 10-1/32 |          |          |
| 4                              | 4-27/32                        | 7                  | 9-5/32  |         |          |          |
| 5                              | 6-1/8                          | 8-9/32             | 10-1/16 |         |          |          |
| 6                              | 7-13/32                        | 9-9/16             |         |         |          |          |
| 7                              | 8-11/16                        | 10-27/32           |         |         |          |          |
| 8                              | 9-31/32                        |                    |         |         |          |          |

<sup>1</sup> Mill sawing 4/4 lumber at a desired thickness of 32/32 inches (target set) and 8/4 lumber at a desired thickness of 60/32 inches and using a 9/32-inch saw kerf.

<sup>2</sup> Dogboard

The following example shows how a setting guide works while sawing two thickness classes from the same log. A sawyer as he sets for his finish run judges from the log and his setting guide that he can get two  $8/4$  pieces and four  $4/4$  pieces from his cant. He notes from his setting guide that he must begin his run on  $9-5/32$  inches to come out right on the dogboard. He now has the option of working in either direction in the guide to get his pieces in any way he desires. If he decides to cut two boards first, he goes up the scale, first to  $7-7/8$  inches then to  $6-19/32$  inches. Next, he decides to cut one dimension piece and, therefore, moves across the scale to a setting of  $4-7/16$  inches. He then decides on another board and moves up the scale to  $3-5/32$  inches; and finally moves up to  $1-7/8$  inches, which results in the last board and the second dimension piece, which also becomes the dog board in this case.





# **EQUIPMENT SELECTION**

## HEADSAW

Selection of the headsaw should be based primarily on the hardest species and the average largest logs to be saw". Several factors must be considered in selecting a headsaw: (1) diameter, (2) gage, (3) style of teeth, (4) hand of mill, (5) number of sawteeth, and (6) width of cutting edge. Because almost all circular mill operators today use inserted tooth saws, the selection and use of solid tooth saws is not covered.

### DIAMETER

The diameter of the headsaw should be the smallest possible that can saw the largest logs expected. Using a saw larger than required increases difficulty in maintaining proper tension and adds to the number of teeth to keep in repair. On the other hand, time and money are often wasted in trying to cut logs larger than a saw can effectively handle. Slabs must be chopped free, often degrading potentially high-grade lumber. It is necessary to recognize the upper diameter limit that a saw can cut and make sure that logs above this limit are kept out of the mill. The following tabulation shows the recommended saw diameters for the corresponding average largest logs that a saw can handle effectively. If a saw larger than 60 inches is needed, a top saw is recommended rather than a larger headsaw.

| <u>Diameter of average<br/>largest logs</u> | <u>Saw Diameter</u> |
|---|---------------------|
| ----- Inches -----                          |                     |
| 18  | 40                  |
| 20  | 44                  |
| 22  | 48                  |
| 26  | 52                  |
| 30  | 56                  |
| 34  | 60                  |

### GAGE

Saw gage should be selected according to the load the saw will encounter under were conditions. Large logs, hard logs, fast saw speeds, and a fast carriage speed all demand, in general, a heavier gage saw to withstand the increased stress. Table 4 shows the recommended saw gages for various tooth and shank styles, saw diameters, and load conditions.

**Table 4. – Recommended saw gages for various tooth styles, saw sizes, and load demands**

| Tooth style | Saw diameter    |             |            |            |             |            |
|-------------|-----------------|-------------|------------|------------|-------------|------------|
|             | 40" to 54"      |             |            | 56" to 62" |             |            |
|             | Light load      | Medium load | Heavy load | Light load | Medium load | Heavy load |
|             | -----Gages----- |             |            |            |             |            |
| 2-1/2, F    | 9/10            | 8/9         | 7/8        | 8/9        | 7/8         |            |
| B, 3        | 8/9             | 7/8         | 6/7        | 7/8        | 6/7         | 6/7        |
| 3-1/2       |                 | 7/8         | 5/6        | 7/8        | 6/7         | 5/6        |
| D, 4-1/2    |                 | 6/7         | 5/6        | 6/7        | 5/6         | 5/6        |

**STYLE OF TEETH**

Any tooth style can be made to work in most any sawing application. Efficient saw operation, however, requires using a tooth style that has been carefully selected for a specific job. For sawing large logs, a tooth style with large gullet capacity is recommended. This large gullet allows the carriage to be fed at the speed required for the saw teeth to maintain the proper bite, provided the power is adequate. Using large gullet capacity on large logs also results in efficient utilization of power. Sawing smaller logs, where large gullet capacity is not required, demands more saw teeth to help prevent the saw from dodging in the cut, especially in knotty logs. A saw with the maximum number of teeth permits the fastest possible carriage speed, resulting in maximum production from the saw.

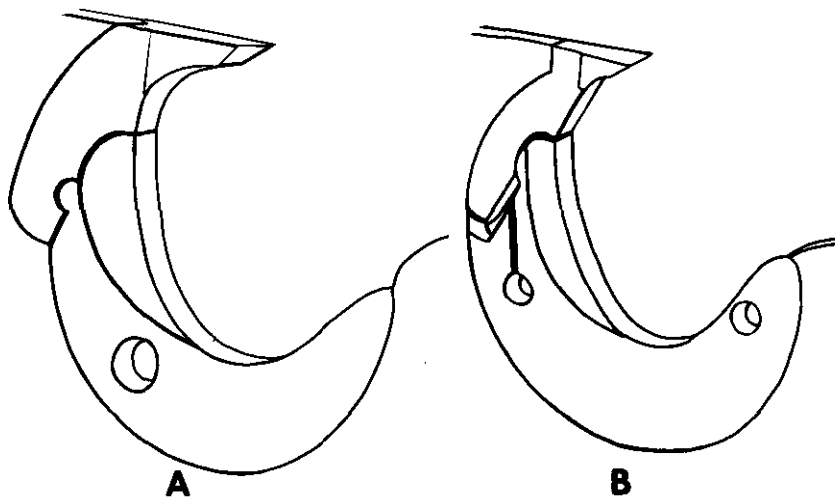

*Figure 4. – The bit of a double-circle F-style tooth (A) has a wider body than that of a single-circle 3-style tooth (B).*

Figure 4 shows the two basic styles of saw teeth – single circle (designated by numbers) and double circle (designated by letters). Double-circle saw teeth are longer and stouter than single-circle saw teeth. Therefore, a saw of given diameter will hold fewer teeth if equipped with double-circle style rather than single circle. The sockets of double-circle teeth absorb shock in such a way as to minimize spreading, which the sockets of single-circle teeth are more prone to do. Spreading sockets upset saw tension and therefore saw performance.

Using a special chip-breaker bit is often helpful while sawing frozen logs (fig. 5). These teeth have a nub projecting into the gullet area that breaks up the swirling action of the sawdust as it chambers. Heat generated by the cutting action of the sawing process and from friction of the fast-moving sawdust causes a partial melting of the ice in the wood. As the sawdust comes to rest the water quickly refreezes causing the sawdust to stick to the board and cant which forces the saw off line. In sawing unfrozen logs, this swirling action of the sawdust normally causes no problem.

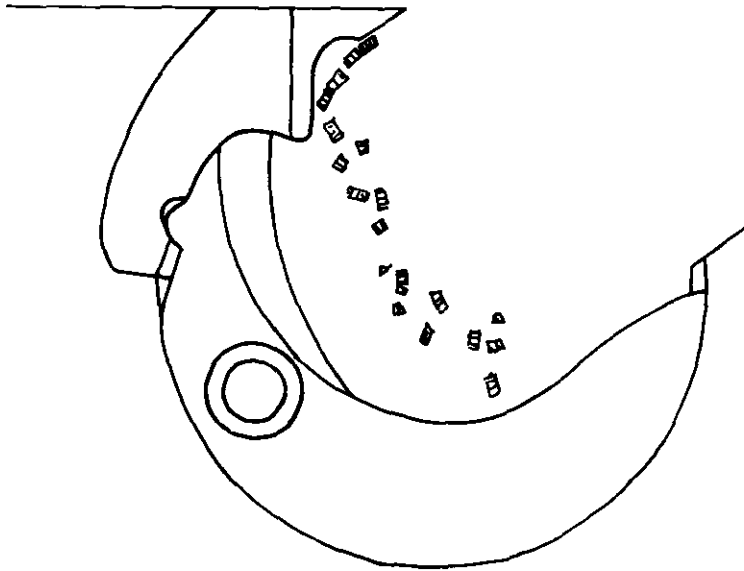

*Figure 5. – Special sawteeth are made with a nub that projects into the gullet area to deflect sawdust away from the flange of the shank. This type of sawtooth works especially well for sawing frozen timber.*

A tooth must cut through a given thickness of wood before the gullet becomes filled. Wood as sawdust in the gullet occupies approximately 43 percent more space than it does as solid wood. Since the gullet capacities of various tooth styles vary considerably, it is important to use the proper style for the size of logs to be sawed. Inefficient headsaw operation results if tooth style is not selected accord-

ing to the average largest logs sawn. For example, using a 2-1/2 style tooth on 22-inch diameter logs will not allow a carriage speed that results in the production of coarse sawdust. Using a D style tooth on 12-inch diameter logs restricts carriage speed because the saw contains fewer teeth. See table 5 for recommended tooth styles for various types and sizes of logs.

**Table 5. – Recommended tooth styles<sup>1</sup> for circular headsaws for various types and sizes of logs.**

| Type of logs                   | Diameter range of logs, inches |          |          |
|--------------------------------|--------------------------------|----------|----------|
|                                | 10-19                          | 13-21    | 20-33    |
| Knotty                         | F, 2-1/2                       | B        |          |
| Frozen                         | F, 2-1/2                       | B, 3-1/2 | D, 4-1/2 |
| Hard-hardwoods; bard softwoods | F                              | B        | D        |
| Soft-hardwoods; softwoods      | 2-1/2                          | 3,3-1/2  | 4-1/2    |

<sup>1</sup> Bits in F, B, and D tooth styles are interchangeable, but shanks are not.

#### HAND OF MILL

Most saws are thicker at the center than at the rim and must be hammered for right-hand or left-hand mill operation. The extra thickness of the saw plate at its center is all hammered through to one face – the other face then becomes flat. The flat face must run on the log side and the crowned face on the board side. To determine the hand of a saw, stand in the sawyer’s box facing the saw and note on which hand the log passes while being sawed. If it passes from your right – the saw is right hand; if it passes from your left – the saw is left hand (fig. 6).

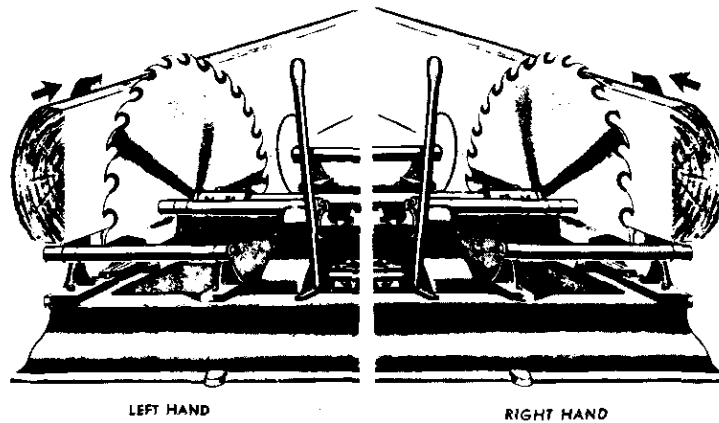

Figure 6. – To determine the hand of a mill, position yourself in the sawyer’s box facing the saw and note on which hand the log passes you while it is sawed. *Reproduction courtesy of R. Hoe & Co., Inc.*

## NUMBER OF SAW TEETH

At a given rim speed, a saw with the maximum number of teeth can do more work per unit of time than one with fewer teeth. But keep in mind that horse-power needs Increase with an increase in number of sawteeth. If available power at the headsaw is insufficient for the saw to maintain the proper bite, either a saw with fewer teeth should be used or the power should be increased. Table 6 shows the maximum number of inserted teeth for standard saws of given diameter.

**Table 6. – Maximum number of inserted teeth in standard headsaws<sup>1</sup>**

| Tooth style | Saw diameter, inches |    |    |    |    |    |    |    |    |    |
|-------------|----------------------|----|----|----|----|----|----|----|----|----|
|             | 40                   | 42 | 44 | 46 | 48 | 50 | 52 | 54 | 56 | 60 |
|             | ----- Number -----   |    |    |    |    |    |    |    |    |    |
| 2-112       | 44                   | 46 | 48 | 50 | 54 | 56 |    |    |    |    |
| F           |                      |    | 42 | 44 | 46 | 48 | 50 | 52 | 54 |    |
| B           |                      |    | 34 | 38 | 42 | 42 | 44 | 44 | 48 |    |
| 3           |                      |    | 40 | 42 | 46 | 48 | 50 | 50 | 50 |    |
| 3-1/2       |                      |    | 38 | 40 | 42 | 44 | 46 | 48 | 50 | 52 |
| D           |                      |    |    |    | 36 | 36 | 36 | 40 | 40 | 44 |
| 4-1/2       |                      |    |    |    | 38 | 40 | 40 | 44 | 44 | 44 |

<sup>1</sup> The table indicates the maximum available in saws which manufacturers will guarantee. Saws with a larger number of teeth are obtainable on special order but are not generally recommended because of excessive shoulder breakage.

## WIDTH OF CUTTING EDGE

The cutting edge of saw teeth must provide a path (saw kerf) wide enough for the saw plate to clear without making excessive contact with the wood. If excessive contact is made during the cut, resulting friction usually causes the saw plate to heat and expand. This, of course, leads to sawing problems and makes it impossible to saw accurate lumber.

In general, softwoods require a wider saw kerf than hardwoods because softwoods tend to be more “fuzzy grained”. Softwoods in general do not cut as cleanly and smoothly as most hardwoods. Basswood, cucumber, and cottonwood are notable exceptions and may require a wider kerf.

A narrower cutting edge can be used in saving frozen wood because all frozen wood generally cuts more cleanly than unfrozen wood. A narrower cutting edge also demands less power, which is especially Important in sawing frozen logs because freezing increases power demand in general. A slowdown in carriage speed is often forced while sawing frozen logs, especially if the cutting edge is wider than necessary.

A wider cutting edge is normally required when using tooth styles with larger gullet capacity and when encountering heavy load demands such as when feeding heavy or sawing large logs. The increased stresses must be absorbed by a heavier gage saw and teeth. Table 7 shows the recommended cutting edge widths of saw teeth as affected by saw gage, tooth style, and type of logs to be sawn.

**Table 7 – Recommended cutting edge widths of saw teeth**

| <b>UNFROZEN SOFTWOOD</b>           |                       |     |     |     |     |
|------------------------------------|-----------------------|-----|-----|-----|-----|
| Tooth style                        | Saw gage              |     |     |     |     |
|                                    | 9/10                  | 8/9 | 7/8 | 6/7 | 5/6 |
|                                    | ----- 64th inch ----- |     |     |     |     |
| 2-1/2, F                           | 17                    | 18  | 20  |     |     |
| B, 3                               |                       | 18  | 20  | 22  |     |
| 3-1/2                              |                       |     | 20  | 22  | 24  |
| D, 4-1/2                           |                       |     |     | 24  | 26  |
| <b>UNFROZEN HARDWOOD</b>           |                       |     |     |     |     |
| 2-1/2, F                           | 16                    | 17  | 18  |     |     |
| B, 3                               |                       | 17  | 18  | 20  |     |
| 3-1/2                              |                       |     | 18  | 20  | 22  |
| D, 4-1/2                           |                       |     |     | 22  | 24  |
| <b>FROZEN SOFTWOOD OR HARDWOOD</b> |                       |     |     |     |     |
| 2-1/2, F                           | 14-16                 | 16  | 17  |     |     |
| B, 3                               |                       | 16  | 17  | 18  |     |
| 3-1/2                              |                       |     | 17  | 18  | 20  |
| D, 4-1/2                           |                       |     |     | 20  | 22  |

### **SAW ARBOR**

The saw arbor should be matched to the saw speed and the amount of horse-power applied. The arbor shaft must be capable of transmitting smooth, vibrationless rotation to the saw. Any vibration or distortion of the arbor is amplified at the rim of the saw, thus causing erratic performance. The arbor must be stiff enough to withstand the torque loads of the power source and the shock loads resulting from the sawing process. It must also withstand abuse when the carriage is fed too fast for existing conditions, causing the saw to hang<sup>1</sup> suddenly.

<sup>1</sup> The term “hang” as used here describes the condition when a saw is overfed, the gullets are completely filled before the teeth emerge from the bottom of the cut, and the saw stops revolving almost instantly.



Three factors must be considered when selecting an arbor shaft for a given sawmill setup: (1) diameter, (2) rotation speed, and (3) number and type of bearings. Diameter and rotation speed should be considered simultaneously.

**DIAMETER AND ROTATION SPEED**

It is usually best to select shafting of larger diameter, as the greater the diameter the greater its stiffness. Stiffness reduces deflection and vibration and lengthens bearing life as well. Table 8 shows the recommended arbor diameters for the headsaw according to the saw speed, horsepower, and the type of load being sawn. The following example shows how to determine the correct arbor diameter:

Suppose you have a 2-11/16-inch arbor shaft turning at a speed of 600 r.p.m. According to Table 8, this shaft can sustain in the neighborhood of 87 horsepower for a heavy instant load (oak for example) or up to 145 horsepower for a light instant load (such as basswood). But if you wanted to saw primarily oak using about 145 horsepower and a shaft speed of 600 r.p.m., a 2-11/16-inch arbor would probably not give satisfactory operation. The next standard shaft size, 2-15/16 inches, will do a better job because the heavy instant load value is 113 horsepower, which is nearer the 145 horsepower than the previous 87. Going to the next standard shaft size of 3-7/16 inches would be overdesigning since the heavy Instant load value at 600 r.p.m. is 182 horsepower. However, it would do no harm and would provide an additional margin of safety.

**Table 8. – Recommended arbor diameters for the headsaw at given saw speeds and horsepower<sup>1</sup> ranges**

| Arbor speed, r.p.m.  |         |         |         | Arbor diameter |
|----------------------|---------|---------|---------|----------------|
| 400                  | 500     | 600     | 700     |                |
| -----Horsepower----- |         |         |         | <b>Inches</b>  |
| 43-72                | 54-90   | 65-108  | 76-126  | <b>2 -7/16</b> |
| 58-97                | 73-121  | 87-145  | 101-169 | <b>2-11/16</b> |
| 76-126               | 95-158  | 113-189 | 132-221 | <b>2-15/16</b> |
| 121-202              | 151-253 | 182-303 | 212-354 | <b>3-7/16</b>  |
| 182-304              | 228-380 | 273-456 | 319-532 | <b>3-15/16</b> |

<sup>1</sup> Lower h.p. figure indicates heavy instant load; higher h.p. figure indicates light instant load. Data from catalog of Dodge of Mishawaka, Ind.

**NUMBER AND TYPE OF BEARINGS**

Most arbors in today’s sawmills are equipped with low friction, self-aligning roller bearings. Roller bearings have the advantage over bushed or bab-bitted bearings in that they keep the shaft running true and they tend to run cooler, resulting in fewer saw tension problems. Two arbor bearings are generally sufficient for shafts up to 6 feet long. Three bearings are recommended for arbor shafts 7 to 10 feet long. Manufacturers’ recommendations regarding the speed, load, and type of duty expected for arbor bearings should be closely followed.

**SAW COLLARS**

For trouble-free saw operation, both saw collars must be identical and they must be of sufficient size to provide rigid support for the saw plate. Most saw collars are made with a recessed inner section and an outer bearing surface about 3/4-to 7/8-inch wide that contacts the saw plate. The following tabulation shows the recommended collar diameters for various saw sizes:

| <u>Saw diameter</u> | <u>Collar diameter</u> |
|---------------------|------------------------|
| ----- Inches -----  |                        |
| 48-54               | 6                      |
| 56-60               | 7                      |
| Above 60            | 8                      |

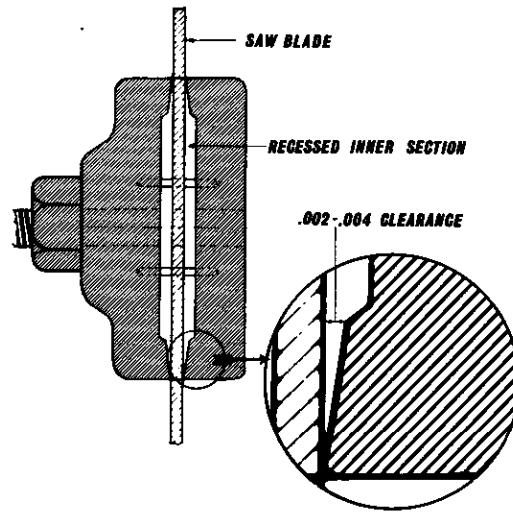
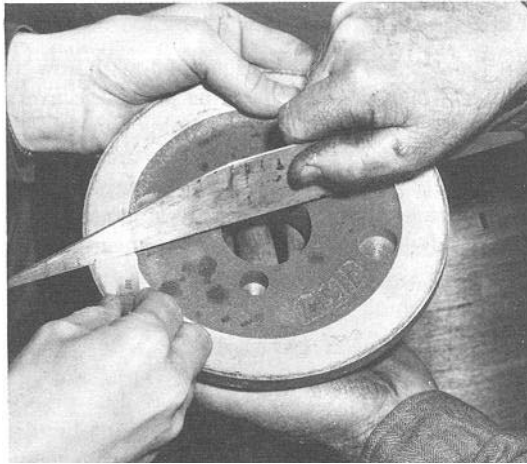

Figure 7. – To insure proper support of the saw blade, collars should be machined with a .002- to .004-inch radial taper on their bearing surface toward the recess.



*Figure 8. – Position a machined straightedge across the face of the collar and check for the amount of taper with a leaf gage on the inside edge of the bearing surface.*

Saw collars should be machined to provide maximum support for the saw plate. Machining the bearing surfaces of each collar with a slight radial taper toward the collar recess will help to accomplish this (fig. 7). The outer periphery of the bearing surface will then make positive contact with the saw plate after the arbor nut has been tightened properly. The amount of taper should be from .002 to .044 inch in the width of the bearing surface. Figure 8 shows how collar taper can be checked.

## **PULLEYS AND V-BELTS<sup>1</sup>**

To insure full use of available power to the headsaw, an effective means of transmission must be provided. Since V-belt drives are almost universally used in modern sawmills, other types of power transmission systems will not be covered.

Factors to consider in a V-belt system are: (1) belt size, (2) pulley sizes, and (3) number of belts. Also, to insure best performance, the belt transmission system should be designed so that belt speed does not exceed the limits set by the manufacturer. This is normally about 5,000 to 6,000 f.p.m. Belt speed can be calculated by using the following formula:

$$\text{Belt speed in feet per minute} = 0.262 \times \text{pitch diameter of pulley in inches} \times \text{r.p.m. of shaft.}$$

Pitch diameter is measured from about 2/3 the height of the groove (fig 9).

<sup>1</sup> Most of the data used for illustration in this chapter is based on data from Dodge of Mishawaka, Ind. These data vary among manufacturers, so be sure to check with the particular manufacturer of the belts used.

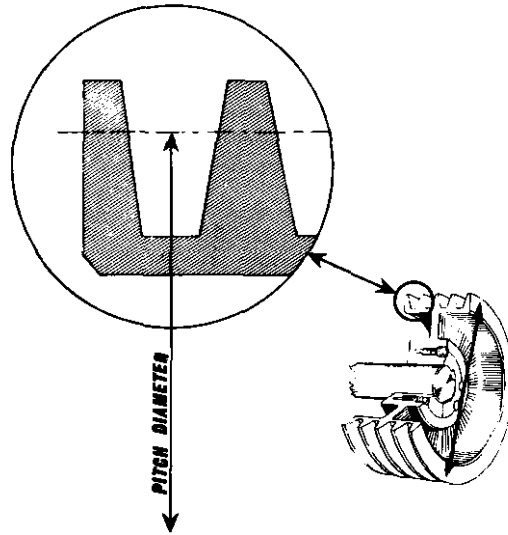

Figure 9.—Pitch diameter of a pulley is measured from about two-thirds the height of the groove.

#### BELT SIZE

Most V-belt manufacturers have standardized their belt sizes according to the cross-sectional area of the belt and have given them the letter designations A, B, C, D, and E. The most common belts used in sawmill power transmission systems are sizes B, C, and D. Table 9 shows the recommended belt sizes for various combinations of horsepower and drive shaft speed.

Table 9. – Recommended V-belt sizes for various horsepower and drive shaft speeds

| Design horsepower <sup>1</sup> | Drive shaft speed, r.p.m. |     |     |          |      |           |      |           |
|--------------------------------|---------------------------|-----|-----|----------|------|-----------|------|-----------|
|                                | 600                       | 700 | 800 | 900-1100 | 1200 | 1300-2000 | 2100 | 2200-3400 |
| 75                             | D                         | D   | D   | D/C      | C    | C         | C/B  | B         |
| 100                            | D                         | D   | D   | D        | D/C  | C         | C/B  | B         |
| 125                            | D                         | D   | D   | D        | D/C  | C         | C/B  | B         |
| 150                            | E                         | D/E | D   | D        | D/C  | C         | C/B  | B         |
| 175 & up                       | E                         | E   | D/E | D        | D/C  | C         | C/B  | B         |

<sup>1</sup> Design horsepower is computed by multiplying maximum horsepower rating by 1.3.

**PULLEY SIZES**

Correct pulley diameter is determined primarily from the kind of power, belt size, and pulley speeds used. Since these factors interact they should be considered collectively when determining pulley sizes.

Within reasonable limits, using the largest pulley possible on the power source permits using the fewest number of belts. This is because the contact area of the belts on a larger pulley hookup is greater than on a smaller pulley hookup, even though the are of contact may be the same in each case. For best performance the size of the pulleys should fall within a certain range according to the belt size used. The following tabulation shows the recommended pitch diameter ranges of the drive pulley for given belt sizes:

| Belt size | Pitch diameter range<br>of drive pulley<br>(inches) |
|-----------|---|
| B         | 4.6- 9.4  |
| C         | 7.0- 16.0   |
| D         | 12.0- 24.0  |
| E         | 18.0- 36.0  |

Table 10 shows the recommended minimum pulley diameters at specified horsepower and shaft speeds when electric motors are used as power sources. While these figures are generally conservative, a specific motor and bearing combination may allow using a smaller motor pulley. When other than a standard hookup is desired, be sure to check with the motor manufacturer:

**Table 10. – Recommended minimum pulley diameters for electric motors at specified horsepower and shaft speeds**

| Motor<br>horsepower | Motor speed, r.p.m. |     |     |      |      |
|---------------------|---------------------|-----|-----|------|------|
|                     | 575                 | 695 | 870 | 1160 | 1750 |
|                     | ----- Inches -----  |     |     |      |      |
| 75                  | 14                  | 13  | 10  | 10   | 9    |
| 100                 | 18                  | 15  | 13  | 13   | 10   |
| 125                 | 20                  | 18  | 15  | 13   | 11   |
| 150                 | 22                  | 20  | 18  | 13   |      |
| 200                 | 22                  | 22  | 22  |      |      |
| 250                 | 22                  | 22  |     |      |      |
| 300                 | 27                  | 21  |     |      |      |

Speed ratio is handy to know while making computations concerning belt and pulley hookups. Figure speed ratio by either: (1) dividing the speed of the driver pulley by the speed of the driven pulley, or (2) dividing the diameter of the driven pulley by the diameter of the driver pulley. For example: Determine

the speed ratio where the speed of the driver pulley is 1,800 r.p.m. and the speed of the driven pulley is 550 r.p.m. Dividing 1,800 by 550 gives a speed ratio of 3.27. If you had decided that the driver pulley diameter should be 13 inches, simply multiply 13 times 3.27 for a driven pulley diameter of 42.51 inches to get the desired 550 r.p.m. on the saw. If you knew the diameter of the driven pulley and wanted to know what diameter the drive pulley should be, then

**Table 11. – Horsepower ratings per belt<sup>1</sup>**

**“B” BELT**

| r.p.m. of driver shaft | Pitch diameter, driver pulley in inches) |      |       |       |       |
|------------------------|--|------|-------|-------|-------|
|                        | 5  | 6    | 7     | 8     | 9     |
| 1,800                  | 5.13                                     | 6.90 | 8.55  | 10.07 | 11.46 |
| 2,200                  | 5.85                                     | 7.94 | 9.61  | 11.13 | 12.53 |
| 2,600                  | 6.32                                     | 8.53 | 10.33 | 11.80 | 12.80 |
| 3,000                  | 6.83                                     | 8.96 | 10.64 | 12.16 |       |
| 3,400                  | 7.06                                     | 9.10 | 10.50 |       |       |

**“C” BELT**

|       | 7     | 9     | 11    | 13    | 16    |
|-------|-------|-------|-------|-------|-------|
| 600   | 5.00  | 7.56  | 10.04 | 12.41 | 15.81 |
| 1,000 | 7.40  | 11.28 | 14.98 | 18.28 | 22.88 |
| 1,400 | 9.34  | 14.25 | 18.55 | 22.25 | 26.45 |
| 1,800 | 10.79 | 16.23 | 20.63 | 23.73 |       |
| 2,200 | 11.68 | 17.20 | 20.80 |       |       |

**“D” BELT**

|       | 12    | 14    | 16    | 18    | 20    |
|-------|-------|-------|-------|-------|-------|
| 600   | 16.81 | 21.81 | 26.71 | 31.31 | 35.81 |
| 800   | 20.55 | 26.75 | 32.55 | 38.05 | 43.05 |
| 1,000 | 23.59 | 30.59 | 36.99 | 42.69 | 47.69 |
| 1,200 | 25.83 | 33.23 | 39.63 | 44.93 | 49.03 |
| 1,400 | 27.17 | 34.47 | 40.37 |       |       |

**“E” BELT**

|       | 18    | 20    | 22    | 24    | 26   |
|-------|-------|-------|-------|-------|------|
| 600   | 37.7  | 44.2  | 50.5  | 56.5  | 62.1 |
| 700   | 41.6  | 48.7  | 55.3  | 61.5  | 67.2 |
| 800   | 44.8  | 52.2  | 59.0  | 65.1  | 70.5 |
| 900   | 47.3  | 54.8  | 61.4  | 67.1  | 71.8 |
| 1,000 | 48.91 | 56.31 | 62.41 | 67.31 |      |

<sup>1</sup> Horsepower ratings include additional horsepower per belt for speed ratios of 2.00 and above, generally used in sawmill headsaw hookups.

divide by the speed ratio. Check these calculations for correctness by multiplying the diameter times the speed for each pulley of a given hookup; the results will be equal (or nearly so) if the figures are correct.

### NUMBER OF BELTS

The number of belts is determined by the amount of horsepower that each belt is capable of transmitting to the saw in a given hookup. This transmission capability is determined from the belt size, pulley diameters, pulley speeds, belt length, and the arc of contact.

Table 11 shows basic horsepower ratings per belt for combinations of belt sizes, pulley diameters, and pulley speeds. Correction factors for belt length and arc of contact must be applied when using this table.

In determining the belt length correction factor, the distance between pulley centers must be known. The recommended center distance, C, should be either D or  $\frac{D + 3d}{2}$ ; whichever is greater. D is the pitch diameter of the larger pulley and d is pitch diameter of the smaller pulley.

The center distance, C, is then used in the following formula to find belt length:

$$\text{Belt length} = 1.57 (D + d) + 2C$$

Belt length is then used in table 12 to find the appropriate correction factor to apply to the basic horsepower rating determined in table 11.

Usually, the driver pulley is smaller in diameter than the driven pulley in the power-source-headsaw hookup. On the smaller pulley, surface contact between the belt and pulley is reduced, which limits the power transmission capability.

**Table 12. – Correction factors for various belt lengths to be applied to horsepower ratings in Table 11**

| Belt length<br>(Inches) | Belt size |      |      |      |
|-------------------------|-----------|------|------|------|
|                         | B         | C    | D    | E    |
| 100                     | 1.02      | .92  |      |      |
| 120                     | 1.07      | .96  | .86  |      |
| 140                     | 1.10      | .99  | .89  |      |
| 160                     | 1.13      | 1.02 | .92  |      |
| 180                     | 1.16      | 1.05 | .94  | .91  |
| 200                     | 1.18      | 1.07 | .96  | .92  |
| 220                     | 1.20      | 1.09 | .98  | .94  |
| 240                     | 1.22      | 1.11 | 1.00 | .96  |
| 260                     | 1.24      | 1.13 | 1.02 | .98  |
| 280                     | 1.26      | 1.15 | 1.04 | 1.00 |
| 300                     | 1.27      | 1.16 | 1.05 | 1.01 |
| 320                     |           | 1.18 | 1.06 | 1.02 |

The arc of contact must be considered when determining the horsepower rating per belt. It can be found by using the following formula:

$$\text{Arc of contact} = 180^\circ - \frac{(D - d) 60}{C}$$

The arc of contact value is then used in table 13 to find the appropriate correction factor which is applied to the basic horsepower rating determined in table 11.

The following example illustrates the use of these correction factors. Calculate the net horsepower per belt for the following conditions:

- Belt size – D
- Driver pulley diameter – 16 inches
- Speed of driver pulley – 1,000 r.p.m.
- Belt length – 160 inches
- Arc of contact – 130 degrees

From table 11 the basic horsepower rating per belt is 36.99. From table 12 the correction factor for a ‘D’ belt 160 inches long is .92. From table 13 the correction factor for an arc of contact of 130 degrees is .86. Therefore: 36.99 x .92 x .86 = 29.27 which is the corrected horsepower per belt.

To determine the correct number of belts needed, divide the design horsepower by the corrected horsepower per belt. Assume the design horsepower is 150. This divided by 29.27 equals 5.12 or 5 ‘D’ belts to do the job adequately.

**Table 13. – Correction factors for various arc-of-contact values to be applied to horsepower ratings in Table 11**

| Arc of contact<br>(Degrees) | Correction<br>Factor |
|-----------------------------|----------------------|
| 170                         | .98                  |
| 160                         | .95                  |
| 150                         | .92                  |
| 140                         | .89                  |
| 130                         | .86                  |
| 120                         | .82                  |
| 110                         | .79                  |
| 100                         | .73                  |



## POWER

Power units are rated in various ways for the amount of work they can accomplish in a given time. In sawmill work, where speed of the power unit is usually constant but under fluctuating load conditions, a rating for maximum brake horsepower should be used. The conditions under which power ratings are made should be known, otherwise horsepower ratings can be misleading. For example, if the shaft speed of the power source is slower than that specified the given horsepower rating will not be attained.

The horsepower rating does not indicate adequately the torque-producing or twisting capability. Torque is determined largely by the design of the power unit. A power unit capable of producing high torque at slow shaft speeds is desirable for sawmill application. This is usually found in large-bore, long-stroke industrial engines, which deliver steady power and provide dependability.

Diesel power units have a better torque curve than gasoline engines and are the most economical to operate overall. Although initial cost of diesel engines is high, this more than offset by economy of operation and long life.

Electric motors provide dependable, steady power; their reliability and simplicity of operation are unsurpassed. Most industrial electric motors of 25 horsepower or larger deliver 2 to 3 times their continuous horsepower ratings for short periods of time, which is ideal for sawmills. Electric motors are easily damaged by overload and burnout, so they are conservatively rated to provide an extra margin of safety, and most installations are further protected by circuit breakers.

The amount of horsepower required at the headsaw is determined by several interrelated factors: (1) bite, (2) cant face width to be sawn, (3) width of saw kerf, (4) saw speed, (5) hardness of wood, (6) tooth style, and (7) saw-feed. The horsepower requirements shown in table 14 were determined from a formula developed at the Forest Products Laboratory, Madison, Wis. and are considered basic.

These values, however, must be altered when conditions other than those listed are encountered. For example, the "horsepower table" (table 14) does not include allowances for operation of auxiliary equipment such as feedworks or hydraulic pumps, which frequently are driven by the headsaw power source. The power requirements of such equipment must be computed separately.

## BITE

Bite is the distance the log or cant advances into the saw between successive teeth (fig. 10). The bite is determined from the interaction of the number of teeth in the saw, saw speed, and carriage speed. Bite must have an established value to calculate horsepower requirements.

Saw teeth manufacturers for years have advocated standardizing a bite of 1/8 inch for softwoods and 1/10 inch for hardwoods. A bite value of 1/9 (.11) inch, halfway in between, was used in the preparation of table 14. Under actual sawing conditions bite constantly fluctuates but good saw performance demands that bite be held as nearly as possible between 1/8 and 1/10 inch.

**Table 14. – Basic horsepower required at the headsaw<sup>1</sup>**

| Hardness group | Tooth style | Maximum cant face width | Saw-feed, inches/revolution |     |     |     |     |     |
|----------------|-------------|-------------------------|-----------------------------|-----|-----|-----|-----|-----|
|                |             |                         | 4.0                         | 4.5 | 5.0 | 5.5 | 6.0 | 6.5 |
| Inches         |             |                         |                             |     |     |     |     |     |
| 1              | 2-1/2       | 12                      |                             |     | 66  | 72  | 80  | 86  |
|                | F           | 16                      |                             | 80  | 88  | 95  | 107 | 114 |
|                | B, 3        | 19                      | 91                          | 100 | 110 | 119 | 134 |     |
|                | 3-1/2       | 22                      | 109                         | 120 | 132 | 143 |     |     |
|                | D, 4-1/2    | 28                      | 145                         | 160 | 176 |     |     |     |
| 2              | 2-1/2       | 12                      |                             |     | 78  | 85  | 95  | 102 |
|                | F           | 16                      |                             | 95  | 104 | 113 | 127 | 136 |
|                | B, 3        | 19                      | 108                         | 119 | 130 | 141 | 158 |     |
|                | 3-1/2       | 22                      | 129                         | 143 | 156 | 170 |     |     |
|                | D, 4-1/2    | 28                      | 172                         | 190 | 208 |     |     |     |
| 3              | 2-1/2       | 12                      |                             |     | 97  | 105 | 118 | 126 |
|                | F           | 16                      |                             | 118 | 129 | 140 | 157 | 168 |
|                | B, 3        | 19                      | 133                         | 147 | 161 | 175 | 196 |     |
|                | 3-1/2       | 22                      | 160                         | 176 | 193 | 210 |     |     |
|                | D, 4-1/2    | 28                      | 213                         | 235 | 257 |     |     |     |
| 4              | 2-1/2       | 12                      |                             |     | 117 | 127 | 142 | 152 |
|                | F           | 16                      |                             | 142 | 156 | 169 | 189 | 203 |
|                | B, 3        | 19                      | 161                         | 178 | 195 | 211 | 237 |     |
|                | 3-1/2       | 22                      | 193                         | 213 | 233 | 254 |     |     |
|                | D, 4-1/2    | 28                      | 257                         | 284 | 311 |     |     |     |

<sup>1</sup> Basic horsepower values in this table are based on the following constants: standard bite (.11 inch); maximum cant face width for tooth style; saw kerf of 9/32 inch; and saw speed of 550 r.p.m. For each 1/32-inch increase or decrease in kerf width, adjust basic horsepower values by 11 percent. For a saw speed other than 550 r.p.m. multiply basic horsepower values times the appropriate correction factor as follows:

| Saw speed (r.p.m.) | Correction Factor |
|--------------------|-------------------|
| 400                | .75               |
| 450                | .82               |
| 500                | .91               |
| 600                | 1.09              |
| 650                | 1.18              |
| 700                | 1.28              |
| 750                | 1.37              |

A bite greater than 1/8 inch is not generally desirable since the wood often tears, resulting in a jagged appearance. Taking a large bite also makes it easier to overfeed and hang a saw, especially when cutting large, dense knots. Saw teeth and shoulders are not designed to withstand the increased stress in taking a large bite.

Proper bite in this manual implies .11 inch and will hereafter be referred to as the standard bite. It simply implies the base value used in computing horsepower requirements as given in table 14.

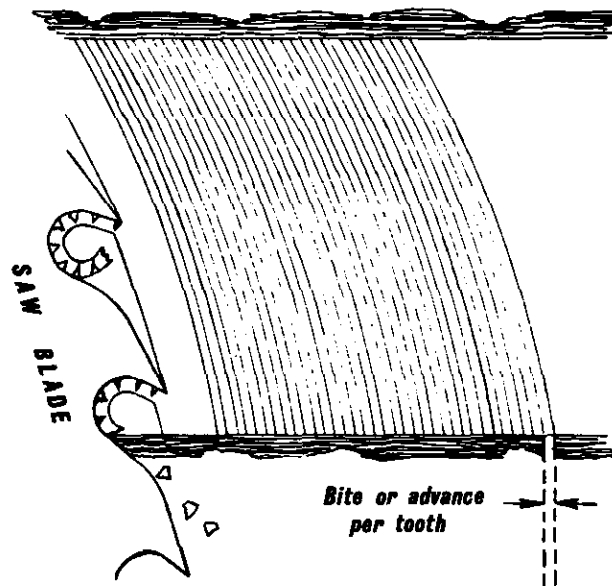

Figure 10.—Bite is the distance the log or cant advances into the saw between successive teeth.

#### CANT FACE WIDTH

As with bite, cant face width must also have established value to calculate horsepower requirements. The value selected here should be based on a cant face width that fills the gullet to capacity with sawdust at a specified bite.

Wider cant face widths can be sawn occasionally by taking a smaller bite, but if this is done regularly, saw operating efficiency is compromised. Gullet capacity should be sufficient to allow sawing the cant face widths encountered at the standard bite. Table 14 shows the horsepower requirements for sawing the maximum cant face width for various tooth styles, based on loading the gullet to capacity at the standard bite.

#### WIDTH OF SAW KERF

Each 1/32-inch change in kerf width affects horsepower requirements shown in table 14 by about 11 percent. Horsepower values in the table are based on a

standard kerf width of 9/32 inch, and they can be adjusted by 11 percent for each 1/32-inch increase or decrease in kerf width from this standard. If kerf width is greater than the standard, precede the adjustment percentage by 1 and use this as the adjustment factor; for example, 10/32-inch kerf would be 1.11. If kerf width is less than the standard, subtract the adjustment percentage from 100 and use this as the adjustment factor; for example, 8/32-inch kerf would be .89. Multiply the basic horsepower in the table by the appropriate adjustment factor to arrive at the required horsepower.

### SAW SPEED

In general, for good saw performance, a rim speed of 8,000 to 9,000 feet per minute is recommended for sawing hardwoods; 10,000 to 11,000 f.p.m. for softwoods; and 6,000 to 7,000 f.p.m. for frozen woods. The relationship of saw diameter and saw speed necessary to attain a predetermined rim speed is given in table 15.

The basic horsepower values shown in table 14 are for headsaws turning at a speed of 550 r.p.m. Horsepower requirements for saw speeds other than 550 r.p.m. are arrived at by multiplying the basic horsepower values in the table by a correction factor for the desired speed as given in the footnote to the table.

**Table 15. – Speed of circular saws at designated rim speeds**

| Saw diameter | Rim speed of saw, surface feet per minute |       |       |       |        |        |
|--------------|---|-------|-------|-------|--------|--------|
|              | 6,000                                     | 7,000 | 8,000 | 9,000 | 10,000 | 11,000 |
| Inches       | ----- r.p.m. -----                        |       |       |       |        |        |
| 40           | 573                                       | 668   | 764   | 859   | 955    | 1,050  |
| 42           | 546                                       | 637   | 728   | 819   | 909    | 1,000  |
| 44           | 521                                       | 608   | 694   | 781   | 868    | 955    |
| 46           | 498                                       | 581   | 664   | 747   | 830    | 913    |
| 48           | 477                                       | 557   | 637   | 716   | 796    | 875    |
| 50           | 458                                       | 535   | 611   | 688   | 764    | 840    |
| 52           | 441                                       | 514   | 588   | 661   | 735    | 808    |
| 54           | 424                                       | 495   | 566   | 637   | 707    | 778    |
| 56           | 409                                       | 477   | 546   | 614   | 682    | 750    |
| 58           | 395                                       | 461   | 527   | 593   | 659    | 724    |
| 60           | 382                                       | 446   | 509   | 573   | 637    | 700    |

## HARDNESS OF WOOD

The hardness of wood has a direct effect on horsepower requirements. This effect is incorporated into the horsepower table by using four hardness groups. All commercial sawtimber sawn in the United States falls into one of these groups depending on specific gravity value, as follows:

| <u>Hardness Group</u> | <u>Specific gravity</u> |
|-----------------------|-------------------------|
| 1                     | 0.35 and less           |
| 2                     | 0.36 – 0.45             |
| 3                     | 0.46 – 0.55             |
| 4                     | 0.56 and above          |

Specific gravity values for most commercially important timber species in the United States are listed on page 82.

In choosing the proper hardness group, consider which of the groups of species sawn will comprise at least 95 percent of the production. For example, suppose the mix of species to be sawn includes 75 percent red oak, 10 percent yellow-poplar, 5 percent basswood, 5 percent cherry, and 5 percent shagbark hickory. Group 3 would be the correct choice because 95 percent of the species in this mix are no harder than this group.

## TOOTH STYLE

The effect of tooth style on horsepower requirements is directly related to the gullet area of the tooth used.

| <u>Tooth style</u> | <u>Gullet Area<br/>Square Inches</u> |
|--------------------|--------------------------------------|
| 2-1/2              | 1.5                                  |
| F                  | 2.0                                  |
| 3, B               | 2.5                                  |
| 3-1/2              | 3.0                                  |
| D, 4-1/2           | 4.0                                  |

These are approximate values and are constant for each tooth style. These gullet area values are automatically taken into account in table 14.

Note that horsepower values given in table 14 cannot be compared vertically within a wood hardness group to relate power consumption of one style tooth and shank with another because each style reflects a different width of sawn face. It is possible, however, to compare figures for the same tooth and shank style vertically between hardness groups to determine the effect of hardness on power consumption.

## SAW-FEED

Saw-feed is the distance the log or cant advances into the saw per single revolution of the saw and can often be measured directly on a board or cant

(fig. 11). The saw-feed value can be calculated by multiplying the desired bite times the number of teeth in the saw. Saw-feed values in the following tabulation are based on taking the standard bite (.11 inch) and are rounded off to the nearest 1/2 inch:

| <u>Number of teeth in saw</u> | <u>Saw-feed value<br/>Inches/revolution</u> |
|-------------------------------|---|
| 36-38                         | 4.0   |
| 40-42                         | 4.5   |
| 44-46                         | 5.0   |
| 48-50-52                      | 5.5   |
| 54-56                         | 6.0   |
| 58-60                         | 6.5   |

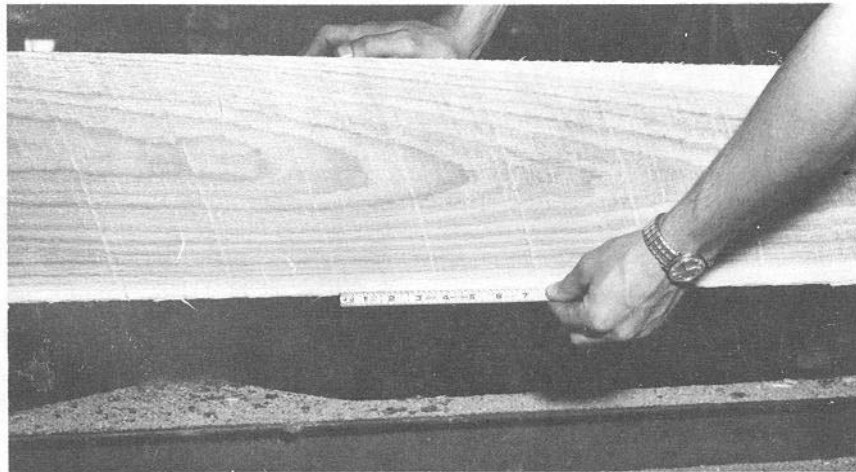

*Figure 11.—A tooth swaged extra heavy on the log side scores the cant in each revolution. The distance between the score marks is the saw-feed, 3.5 inches in this case.*

The saw-feed value for a given saw can be figured simply by counting the number of teeth and noting the corresponding value in the above tabulation. This value can then be used directly in table 14 to determine horsepower requirements.

#### **SUMMARY**

The following example shows how to determine horsepower required at the headsaw: Calculate horsepower required for a style 3, 52-tooth, 5/16-inch kerf saw turning at a speed of 700 r.p.m. and cutting a species mix consisting of 7 percent basswood, 40 percent eastern cottonwood, 50 percent red gum, and 3 percent red oak.

Step 1 – Saw-feed for a 52-tooth saw is 5.5 inches per revolution.

Step 2 – Ninety-seven percent of the species in this mix falls into hardness group 2.

Step 3 – Using the values found in step 1 and 2 and table 14, the basic horsepower value is 141.

Step 4 – The speed correction factor for 700 r.p.m. is 1.28.

Step 5 –The kerf width is increased by 1/32 inch (11 percent) for an adjustment factor of 1.11.

Step 6 – Multiply the basic horsepower value found in step 3 times the speed adjustment factor found in step 4 and the kerf width adjustment factor found in step 5.

Therefore,  $141 \times 1.28 \times 1.11 = 200.33$ , or 200 horsepower required to maintain this saw operating at a speed of 700 r.p.m., feeding at a rate of 5.5 inches per revolution, and cutting a maximum cant face width of no more than 19 inches in a log mix consisting of 95 percent of those species in hardness group 2 without appreciable reduction of saw speed. Required carriage speed, in this case, is 321 feet per minute.

### CARRIAGE AND TRACKS

Size and weight are two prime considerations in selecting a carriage. Unless logs longer than 20 feet are to be sawed, the standard 16-foot carriage is adequate for most sawmill applications. Weight varies from about 4,000 pounds on smaller carriages to more than 16,000 pounds on larger ones. Carriage weight should be kept to a minimum because moving excess weight is costly without returning anything to the operation. However, a carriage must be heavy enough to withstand the expected shock loads, especially if a mechanized log turner is used and high production is the goal.

A carriage should be equipped with sufficient headblock-knee assemblies to adequately support and hold the logs to be sawn. As a general rule, two head-block-knee assemblies are sufficient for softwood logs up to 12 feet long. Three are adequate for logs up to 16 feet long and for logs 16 inches and greater in diameter up to 20 feet long. For logs under 16 inches in diameter and longer than 16 feet, four headblocks should be used. Overhang on logs under 16 inches in diameter should not exceed 2 feet.

For hardwoods, 4 headblocks should be used to assure that logs 10 feet and longer

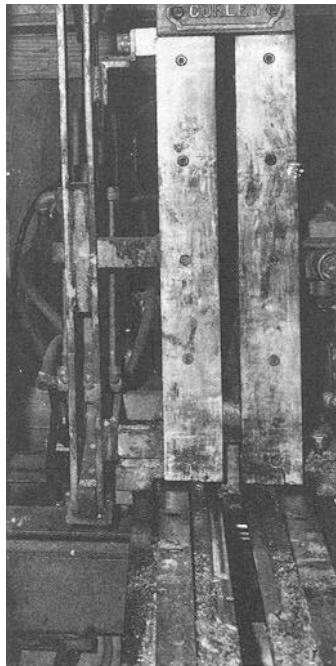
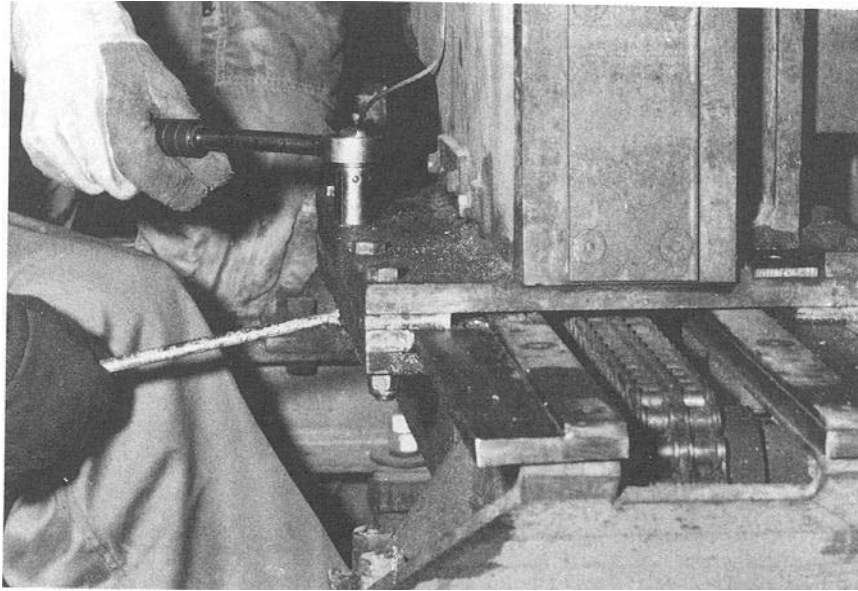

Figure 12.—Headblock and knee with renewable wear plates.

will be dogged in at least three places. Much of the inaccuracy in sawing hardwoods results from the log being held in only two places and not restraining growth stresses while sawing.

Knee openings vary from about 24 inches on small, light duty carriages to more than 60 inches on larger, heavy duty models. A 34-inch knee opening can accommodate logs up to about 30 inches in diameter.

A desirable feature of headblock-knee assemblies is renewable wear plates (fig. 12). These are generally reversible steel plates on headblock and knee faces against which the log or cant rests. Between the sliding surfaces of the knees and headblock bases are replaceable brass or bronze shim strips. As wear occurs, these can be adjusted to remove slack from the knees (fig. 13). Maintenance of the headblock-knee assembly is simplified by the use of these wear plates and shim strips.



*Figure 13. – Adjust shim strips between sliding surfaces of the headblock and knee to remove slack.*

Taper set-out capability is desirable to recover full length lumber from high-grade, tapered logs. Taper set-out varies from 0 to about 4 or 5 inches.

The size and number of trucks should be sufficient to carry the expected loads. In general, 3 trucks are adequate for small, light duty carriages, 4 trucks for medium duty, and 5 or 6 trucks for heavy duty ones. Wheels are generally machined from alloy steel and their diameter varies from about 10 to 18 inches.

Most carriages have fixed axles and wheels that turn independently of each other. This eliminates slippage between the wheels and rails caused by different track design and the resultant uneven wear. Guide rail wheels should be accurately machined to fit the bevel of the rail and should not ride its flat top surface. This eliminates side play and insures that carriage travel conforms to the exact alignment of the rail.



For smooth operation of the carriage, trucks should be equipped with low-friction roller bearings. Provision is often made on each axle for adjusting the entire carriage in relation to the saw line as well as adjusting the position of guide wheels in relation to each other.

The selection of a setworks should be given careful consideration. Most mechanized setworks are powered either by air, electricity, hydraulics, or some combination of these. One important requirement of any setworks is its ability to set accurately and consistently both large and small logs to tolerances of 1/32 inch or less.

Newer carriages use single or double roller chains from the set shaft to drive the knees (fig. 14). Chain tension is readily adjustable to eliminate slack in the knees as wear develops. Some rack and pinion gears are made from hardened steel with machine-cut 'teeth which provide good service and long life. Many larger carriages are made with adjustable, demountable racks that can be easily replaced. Most carriages have a provision for adjusting the rack and pinion gear for precise mesh. It is nearly impossible, however, to remove all slack from a rack and pinion gear arrangement. Some carriages have pinion gears that are split with a built-in spring to help keep out slack.

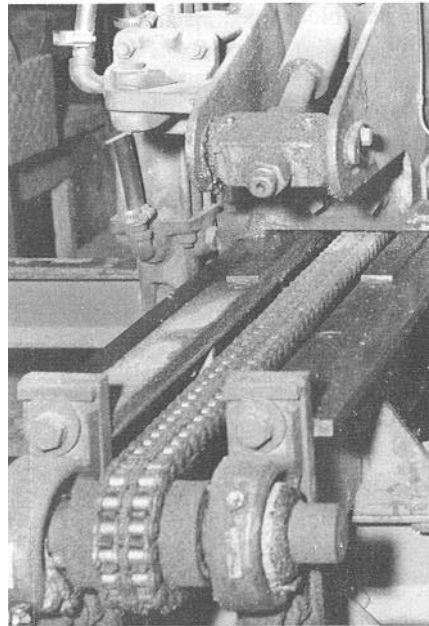

*Figure 14.—Knees on this carriage are driven by a double roller chain from the set shaft.*

Three basic types of dogs used on newer carriages are non-defacing, straight-line-action dogs; tong dogs; and hammer dogs (fig. 15). Most dogs on mechanized carriages are powered by air.

Non-defacing, straight-line-action dogs are often equipped with two or more spring loaded top bits that retract when not needed. Positive stops which prevent the dogs from extending into the saw line are a desirable safety feature.

Tong dogs are widely used as they are readily adapted to mechanized operation, are non-defacing, and provide for a sure grip on the log or cant. They consist of one or two upper dogs and a lower dog, both of which grab the log and pull it tight against the knees as they are set.

Hammer dogs (also called hook dogs) are used primarily to hold larger-than-average logs while making the first cuts on a log. After the log has been reduced in size and a flat surface placed on the headblocks, the regular dogs are able to take over and function normally. Carriages are generally equipped with only one hammer dog.

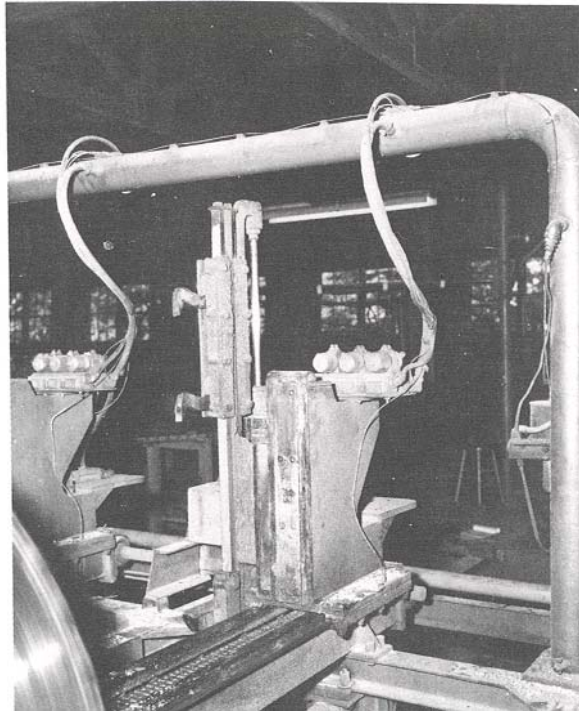

**A**

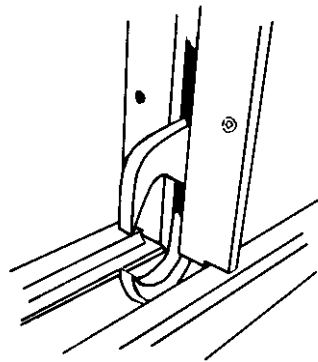

**B**

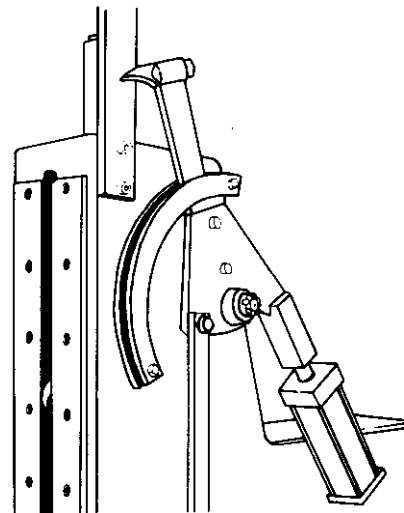

**C**

*Figure 15.—Three basic types of dogs used on newer carriages are (A) non-defacing, straight-line-action dogs, (B) tong dogs, and (C) hammer dogs.*



## **EQUIPMENT SETUP**

## MILL FOUNDATION

The main function of the mill foundation is to provide immovable support for mill machinery. Vibration or excessive movement of mill machinery during the sawing process contributes to the production of mismanufactured lumber. Careful planning in the early stages of mill setup can eliminate the need for makeshift installations at a later date. For example, machinery should be installed at comfortable working heights, and ample room for waste conveyors and chains should be planned before installing foundation members.

Large mills that are built off the ground often use all steel foundations. Medium and small mills that are less permanent generally use foundations made from wood and often some concrete. On extremely unstable soil, a reinforced concrete slab may be necessary in setting up a stable mill foundation.

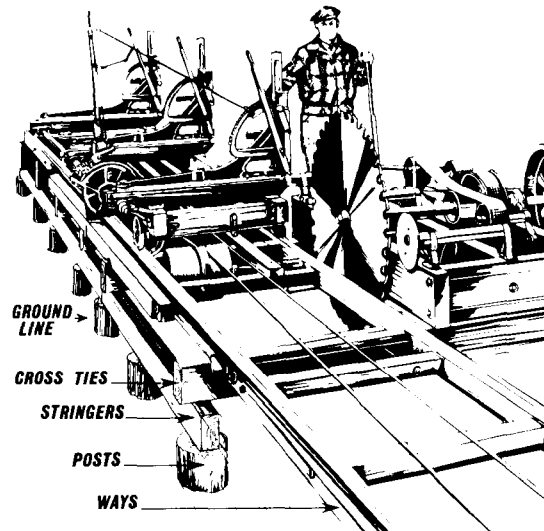
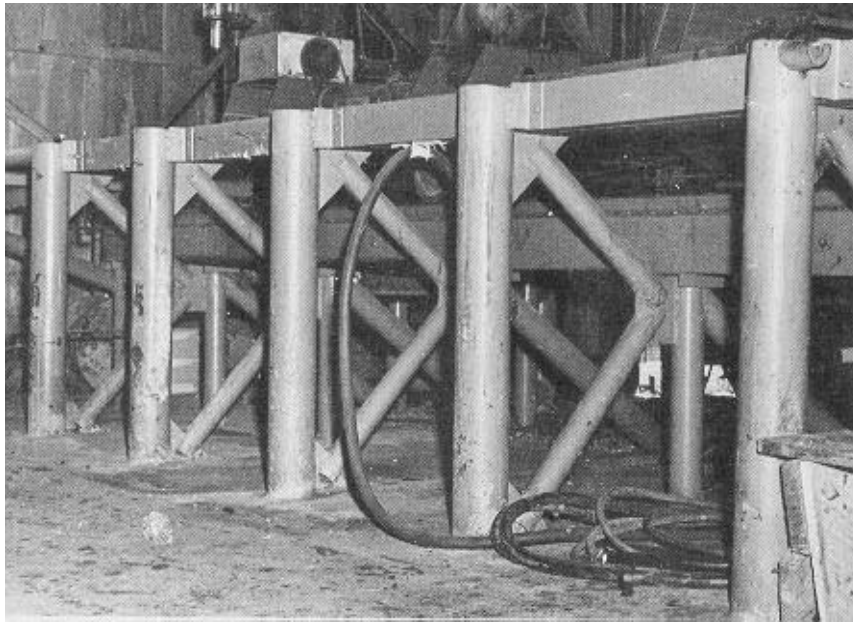

Figure 16.—The relationship of posts, piers, stringers, crossties, and ways in a small sawmill setup. (Retouched reproduction courtesy of R. Hoe & Co., Inc.)

Generally, a foundation consisting of posts or piers, stringers, and crossties is used for medium or smaller sized mills (fig. 16). Posts or upright wooden supports are generally made from pressure-treated poles or decay resistant species, and piers generally are made from reinforced concrete. Concrete piers are often made in the shape of truncated pyramids for greater stability at the base, which should be at least 4 square feet. Posts should be set on reinforced footings of similar size that are at least 6 inches thick. Footings for the base of piers or posts should be imbedded at least 18 inches below the frost line in areas where frost occurs to prevent misalignment of the foundation by frost heave. Piers or posts should be spaced not more than 4 feet apart. Their tops should be at least as wide as the stringers that rest on them.

Stringers and crossties preferably should be made from heartwood timber (preferably free from pith center wood) that is straight-grained, sound, and well air-dried. Decay resistant species, such as heartwood of black locust or white oak, are highly desirable; other material used should be pressure-treated. In no case should green timbers be used, as eventual shrinkage and warping will cause foundation members to shift position. Stringers, which span the piers, should not be less than 8 x 8 inches. Crossties, which rest across the stringers, should be not less than 6 x 6 inches and are usually spaced 2 to 3 feet apart.

The concentration of weight and action of the equipment must be considered in determining bracing requirements. In any case, bracing must be sufficient to provide rigid support for the mill machinery under all operating conditions likely to be encountered (fig. 17).



*Figure 17.—Ample foundation and bracing members are essential for sturdy support of the carriage and other mill components during the sawing process.*

## TRACKS

For cutting lumber accurately, the carriage must travel in a single plane and in a straight line past the saw. The ways and tracks must be installed properly to accomplish this.

Most mills are equipped with a flat track for support of the carriage and its load and a V-track for carriage guidance as well as support. Locating the V-track away from the saw lessens the chance of sawdust and bark falling onto it and causing derailment; also, the carriage is less apt to derail by action of the log turner.

The tracks, which are mounted on the ways, are laid with the guide rail parallel to the face of the saw collar, beginning next to the husk and working out. The tracks should be leveled, both lengthways and crossways, using wedges or shims where necessary. Be sure the track is laid so the end of the headblock base will clear the saw collar by about 1/2 inch. The top of the V-track and the flat track are not in all cases level with each other because of the machining of the track or wheel. Any differences of this kind should be noted before leveling of the V-track is begun; otherwise it may not be possible to place the flat track in an elevation which results in a horizontal top surface of the headblock.

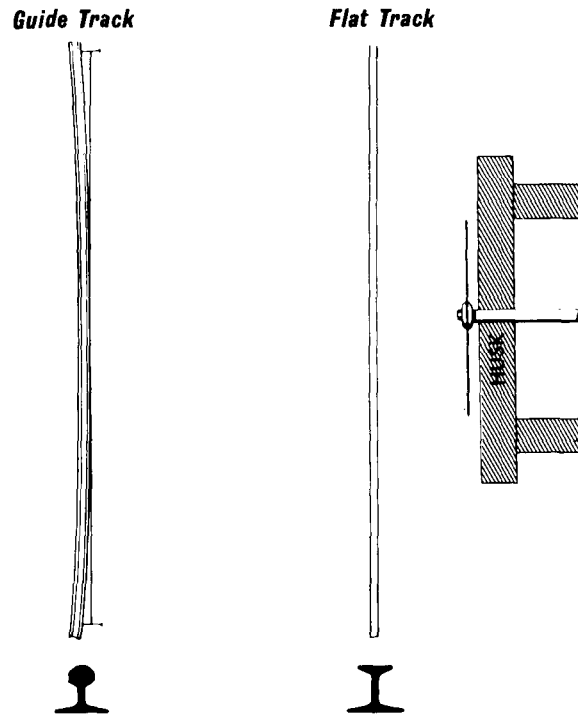

Figure 18.—Check alignment of the guide rail by stretching a string or fine wire above then alongside the rail and measure the distance for uniformity from the wire to the rail at various points.

After the tracks are temporarily fastened in place, the V-track should be aligned straight. To do this, stretch string or fine piano wire above and then alongside the track and measure the distance from the wire to the rail at various points (fig. 18). The V-track can then be fastened permanently in place.

Following alignment of the V-track, the flat track should be cross-leveled to correspond with the V-track. A carpenter's or mason's level can be used to accomplish this.

Guide wheels should be adjusted to eliminate all end play between the wheel and the carriage. Such play results in erratic carriage travel, often causing the saw to heat. Loose axles can cause within-board variation. Check for end play by

giving the carriage a vigorous sideways shove (use a pry bar with a heavy carriage). Wheels, that ride the flat track can float on the axle if designed with bearings in the hub.

Track cleaners must be used to keep tracks free from sawdust and bark (fig. 19). Debris on the track causes the carriage to deflect from a straight line of travel. Even though the amount of deflection may seem small on the track, the effect is amplified several times at the sawing level.

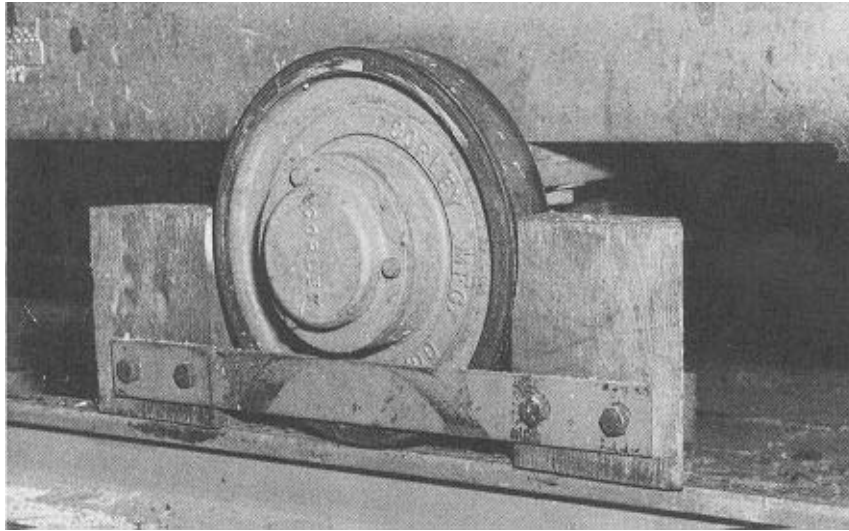

*Figure 19.—Well designed track cleaners are essential in keeping debris off the tracks as well as the wheels.*

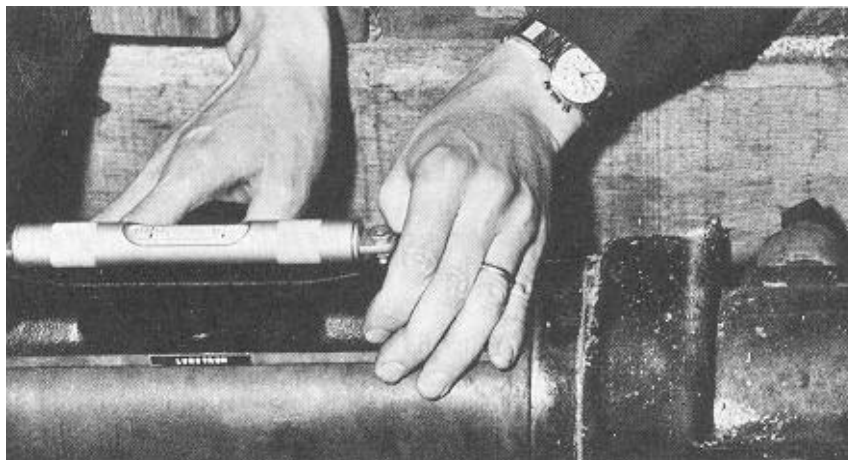

*Figure 20.—Check the level of the saw arbor with a machinist's level.*



## HUSK

The proper installation of the husk and its component parts is essential for safe, trouble-free saw operation and accurate sawing of lumber. Main components of the husk are the arbor, saw, saw guide and splitter.

### ARBOR

The bearing next to the saw should be mounted as close to the fast collar as possible to minimize arbor deflection and vibration. This insures maximum arbor stiffness by decreasing the leverage placed on the bearing while sawing. Similarly, the pulley that transmits power to the arbor should be mounted as close to the husk as possible. If this pulley must be mounted more than 2 feet from the husk an additional outboard bearing should be installed.

To avoid mismanufacturing lumber, the arbor must be installed and maintained in a level position. Use a high quality machinist's level preferably with a notched "V" on the underside to level the arbor (fig. 20). The V helps to insure that the level is positioned correctly for obtaining accurate readings. Since a saw cannot run vertically with an unlevel arbor, it is apt to lead off in the direction it leans resulting in saw problems and mismanufactured lumber.

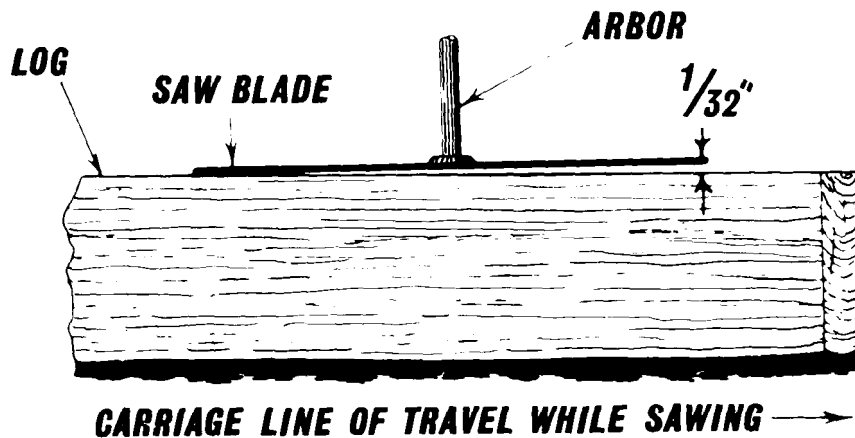
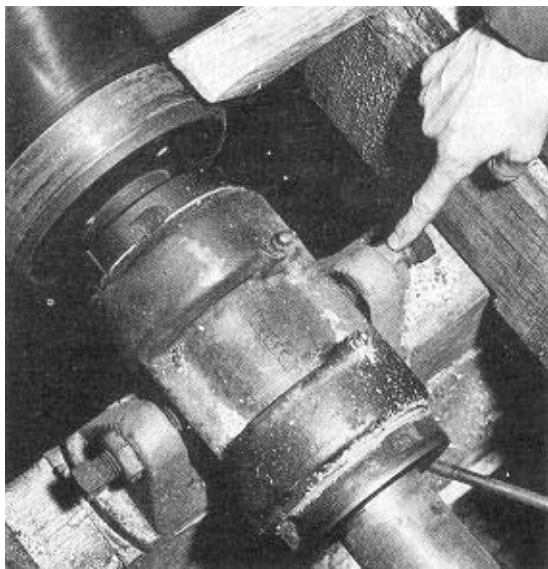

Figure 21.—Lead is put into saw by adjusting the arbor so that backside of the saw is offset approximately  $1/32$  inch relative to the line of carriage travel.

A lead adjustment must be made on the arbor before the saw will run satisfactorily (fig. 21). Lead refers to the slightly nonparallel alignment of the guide track and saw plate, which results in slightly offset carriage travel with respect to the plane of the saw. Lead counteracts the natural tendency for the saw to run out of the log, especially on the slab cut, and also provides clearance for the back of the saw to prevent contact with the cant while sawing.

The lead adjustment can be checked many ways. One commonly used method is as follows:

1. Free guide pins from the saw.
2. Select a sawtooth and mark it.
3. Position No. 1 headblock directly opposite the marked tooth at the front side of the saw.
4. Measure the distance perpendicularly and horizontally from the marked tooth to a fixed point on the headblock.
5. Rotate the saw 180 degrees and move the carriage so that No. 1 headblock is again opposite the marked sawtooth at the back side of the saw.
6. Measure as in No. 4 to the same fixed point on the headblock.



*Figure 22. – Adjust set screws on the saddle of one of the outboard arbor bearings to give the desired lead. Loosen lock nuts before making lead adjustment, and be sure to re-tighten lock nuts after adjustment is completed.*

The second measurement (step No. 6) should read from 1/32 to 1/16 inch more than the front measurement for a correct lead adjustment.

Saws should be run with as little lead as possible. In general less lead is required for fast carriage speed and for hard, close-grained wood, and frozen wood.

Lead should not be forced into the saw by sharpening the teeth with a high side or by adjusting the guide pins to one side. When lead is forced in this way the saw is placed under strain and causes the plate to heat which results in erratic operation and mismanufactured lumber.

Lead is usually set by trial and error and is not necessarily the same for every mill or every saw; it often has to be adjusted several times before the saw will perform satisfactorily. Lead is normally put into the saw by adjusting the set screws located on the saddle of one or both outboard arbor bearings (fig. 22). These set screws are secured by a lock nut which must be loosened prior to making lead adjustments, as follows:

1. Free completely the set screws on the middle bearing (if present) and remove all belt tension from the belt drive hookup.
2. Adjust for lead by shifting the arbor with the set screws on either outboard bearing (do not attempt to set lead with the middle bearing).
3. After lead has been set correctly, close the set screws on the middle bearing carefully. Shaft distortion results if one side is closed in more than the other.

This procedure helps to avoid forcing the arbor off center and putting it under strain. Retighten lock nuts after making the lead adjustment but be careful: over-tightening lock nuts can change the lead adjustment and can crack the bearing saddle. After lock nuts are secured apply normal belt tension to the belt drive system and recheck the lead. If reapplication of belt tension alters the lead setting, lead will have to be reset by repeating the 3-step adjustment process.

If only two arbor bearings are used, belt tension is almost certain to affect the lead adjustment. Therefore, it is necessary to relieve belt tension while adjusting for lead. Be sure to reapply belt tension before making the final lead check.

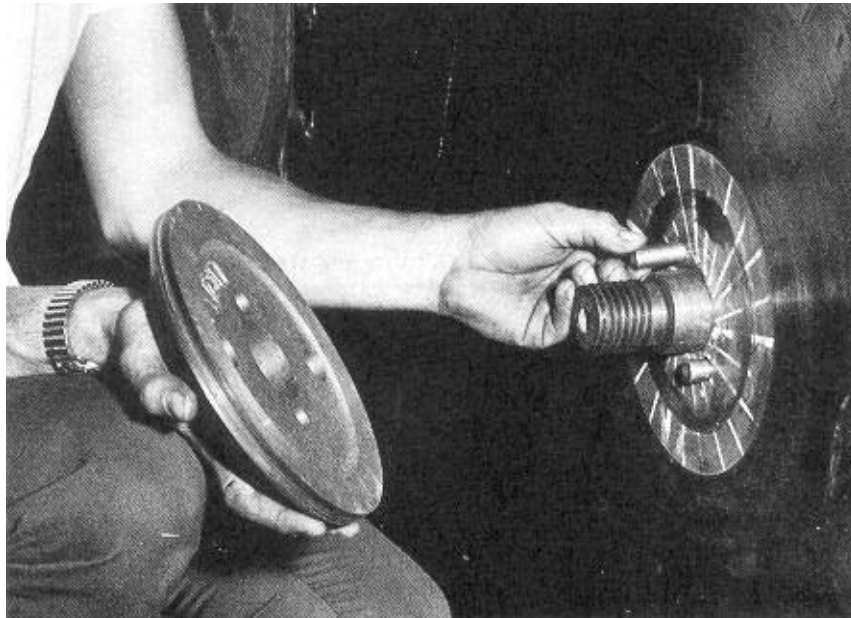

*Figure 23.—Inspect lug pins for damage before replacing the collar and tightening the arbor nut.*

## SAW

For the saw to run vertically the arbor must be perfectly level as evidenced by the face of the fast collar being plumb. Rotate the arbor to at least three different positions and check the collar for plumb at each position with a high quality machinist's level. With the collar plumb, a saw in good condition will also be plumb.

The eye of the saw should fit snugly on the arbor shaft. An overly tight fitting eye causes the saw to bind and prevents the collars from seating properly. A loose fitting eye causes the saw to be eccentric and results in a pounding action and erratic operation.

Clean the end of the arbor, the collars, and the part of the saw that contacts the collars before sliding the saw into place. This is also a good time to examine the collars for nicks, burrs, and other imperfections.

Inspect lug pins for damage as well as proper fit into their holes (fig. 23). Replace notched or burred pins rather than using them until they shear. Such damaged pins can stick in the holes and considerable time and effort is required to drill them out. Some loose collars have two small holes through them which allows stuck or sheared pins to be quickly punched out.

Check lug pins for correct length. Lug pins that are too long will prevent the collars from seating properly and thus render them ineffective for supporting the saw. To check for excessive pin length, remove the saw from the arbor and replace the pins and collar. Do not use the arbor nut. Note the distance between the two collars. It should be less than the thickness of the saw plate. If not, the pins are too long.

Before tightening the arbor nut, rotate the saw backwards tight against the lug pins. Failure to do this may result in the pins shearing the first time the saw is subjected to a severe shock load.

Tighten the arbor nut using muscle power only with a wrench approximately as long as the radius of the saw. Never use a hammer to tighten the arbor nut, as such tightening can result in damage to the collars by flattening the tapered bearing surfaces.

## SAW GUIDE

A saw naturally tends to follow the path of least resistance as it cuts through wood. Surface irregularities, knots, and uneven density within the log can all cause even a sharp saw to deviate from its intended line of cut. The saw guide restrains the saw from wandering off line.

The saw guide must be positioned correctly and fastened securely to the husk frame in order to steady the saw and otherwise function properly. It should clear the ends of the headblocks by about 1 inch. The guide pins should just barely clear the base of the shanks (fig. 24). Guide pins that contact the shanks continually may cause them to heat and crystallize.

Guide pins can be made from almost any hardwood (yellow birch or hard maple are especially long lasting) and should be thoroughly soaked in oil. Leather soaked in oil is also sometimes used.



*Figure 24. – The wear mark on the saw denotes the position of the guide pins. Pins should not make contact with the base of the shanks.*

Guide pins are normally adjusted with the saw running at operating speed. The pins should clear the saw plate by about 1/32 inch or just so daylight is visible between the saw plate and the pins. The pins should not make hard, continual contact with the plate while it is turning as the resulting friction could cause the rim area to heat.

### **SPLITTER**

For safe saw operation, a board splitter should be mounted on the husk frame to within about 1 inch of and directly in line with the backside of the saw. This helps prevent boards from falling back onto the saw and also prevents boards with “spring” in them from pinching the saw.

Two types of board splitters in general use are the circular disk and vertical knife blade. Knife splitters should have a curvature that corresponds to the saw and should be mounted to within 1/2 to 3/4 inch of the saw. Also, the leading edge of the knife should not exceed the thickness of the saw kerf; the back edge should be 1/64 to 1/32 inch thicker to help prevent the teeth from making unnecessary contact with the wood.

**EQUIPMENT  
OPERATION  
AND  
MAINTENANCE**

## CARRIAGE AND SAW SPEED

Saw speed and carriage speed must be in proper relationship for a mill to function properly. A saw that continually turns too fast or a carriage that is continually fed too slow results in unsatisfactory saw performance and ultimately mismanufactured lumber.

The carriage must be fed past the saw at a specified speed to maintain a predetermined bite into the log. Required carriage speed to maintain this bite is determined by the saw-feed and saw speed (table 16). Increasing saw speed or saw-feed are two ways to get more work out of the saw per unit of time; but carriage speed must increase when the saw speed or saw-feed are increased in order to maintain the proper bite. Horsepower requirements also increase when this is done.

**Table 16. – Carriage speed values derived from saw-feed and saw speed at the standard bite<sup>1</sup>**

| Saw speed | Saw-feed (inches per revolution) |     |     |     |     |     |     |
|-----------|----------------------------------|-----|-----|-----|-----|-----|-----|
|           | 3.5                              | 4.0 | 4.5 | 5.0 | 5.5 | 6.0 | 6.5 |
| r.p.m.    | -- Feet per minute --            |     |     |     |     |     |     |
| 400       | 117                              | 133 | 150 | 167 | 183 | 200 | 217 |
| 450       | 131                              | 150 | 169 | 188 | 206 | 225 | 244 |
| 500       | 146                              | 167 | 188 | 208 | 229 | 250 | 271 |
| 550       | 161                              | 183 | 206 | 229 | 252 | 275 | 298 |
| 600       | 175                              | 200 | 225 | 250 | 275 | 300 | 325 |
| 650       | 190                              | 217 | 244 | 271 | 298 | 325 | 352 |
| 700       | 204                              | 233 | 263 | 292 | 321 | 350 | 379 |
| 750       | 219                              | 250 | 281 | 313 | 344 | 375 | 406 |

<sup>1</sup> Standard bite implies .11 inch per tooth.

Once a sawyer knows the required speed of his carriage, he should maintain it to insure the saw takes the proper bite. Carriage speed can be measured directly with a surface speed indicator (fig. 25). If a surface speed indicator is not available, carriage speed can be calculated. First, saw a board in the normal manner. Then measure near the center on the face of this board (or cant) parallel to the edge, the distance to the nearest 1/2 inch between two conspicuous tooth marks that normally occur at regular intervals (fig. 11). This distance is the saw-feed value. If this pattern is not evident, swage one tooth extra heavy on the board side to score the board so the measurement can be taken. Compute the carriage speed (in feet per minute) by multiplying the saw-feed value (as

determined above) times the speed of the saw (in r.p.m.) and dividing the answer by 12. For example:

Saw-feed – 5.5 inches/revolution

Saw speed – 500 r.p.m.

$$\text{Carriage speed} = \frac{5.5 \times 500}{12} = 229 \text{ feet/minute}$$

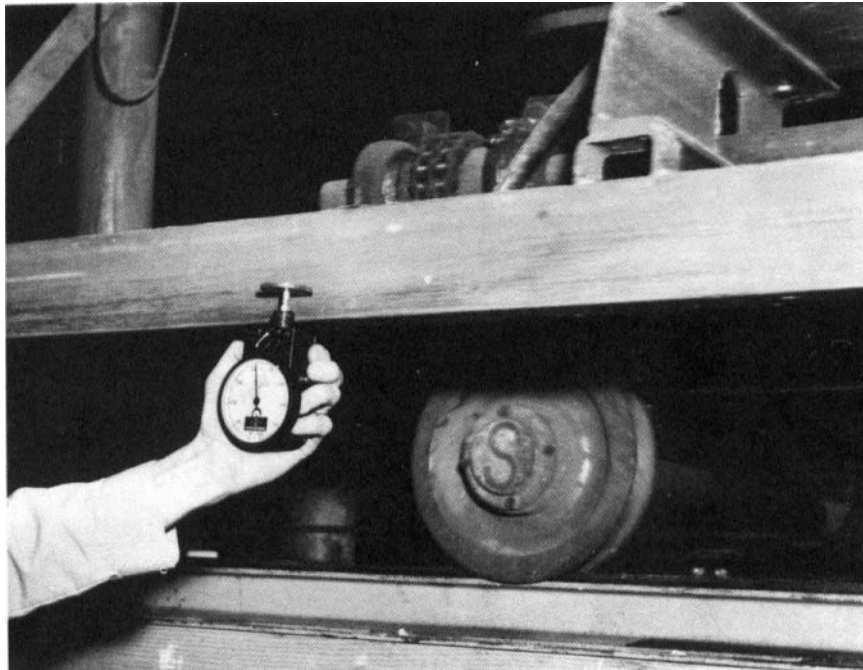

Figure 25.—Carriage speed can be quickly determined by reading directly from a surface speed indicator held against the back bumper.

Another way of determining carriage speed, although less refined, is to use a stopwatch. First, clock as accurately as possible the time it takes for a log of known length to pass through the saw. Express this time as a fractional part of a minute (4 seconds would be 4/60 of a minute). Next, divide the log length by the time, and the answer will be the carriage speed in feet per minute. Table 17 shows carriage speed values derived this way.

Sawmill inefficiency is also reflected in a loss of saw speed, which can result from a variety of causes. Saw speed normally drops from a no-load to a load condition, but it should remain within acceptable tolerances. In general, an adequately powered saw connected properly to the power unit should vary in speed by not more than 50 r.p.m. When saw speed drops excessively, saw tension is affected resulting in erratic operation and ultimately mismanufactured lumber.



Table 17. – Carriage speed values derived from log length and time

| Time required for the log<br>to pass through the saw | Log length, feet          |     |     |     |     |
|--|---------------------------|-----|-----|-----|-----|
|  | 8                         | 10  | 12  | 14  | 16  |
| Seconds  | -----Feet Per minute----- |     |     |     |     |
| 2  | 240                       | 300 | 360 | 420 | 480 |
| 3  | 160                       | 200 | 240 | 280 | 320 |
| 4  | 120                       | 150 | 180 | 210 | 240 |
| 5  | 96                        | 120 | 144 | 168 | 192 |
| 6  | 80                        | 100 | 120 | 140 | 160 |

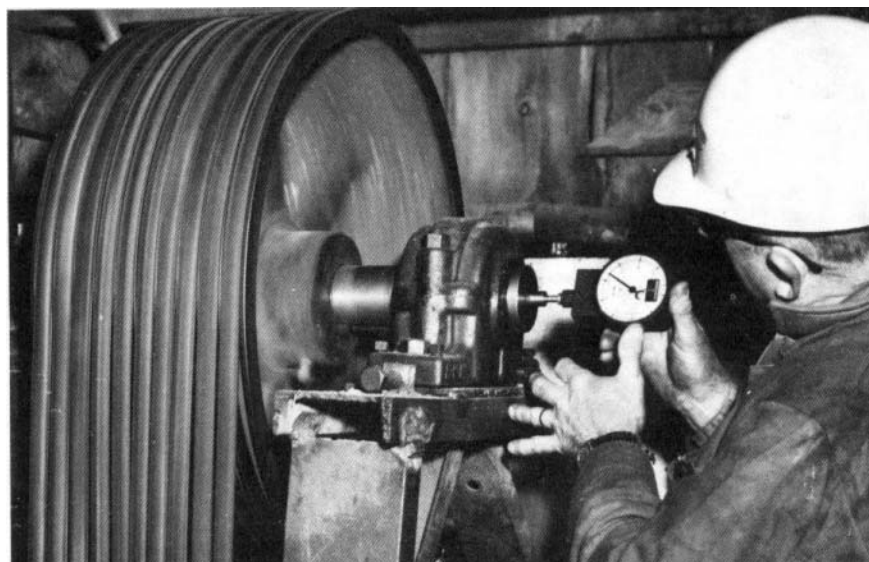

Figure 26. – A quick way to check saw speed is to use a direct-reading speed indicator.

Saw speed should be checked periodically with a tachometer or speed indicator, the direct-reading type being quickest and easiest to use (fig. 26). If one is not available, saw speed can be calculated provided the shaft speed of the power unit is known. Multiply the drive shaft speed times the diameter of the drive pulley and divide the answer by the diameter of the driven pulley (on the saw arbor). The answer will be the saw speed in r.p.m. For example:

$$\begin{array}{rcl}
 \text{Speed of drive pulley} & - & 1,800 \text{ r.p.m.} \\
 \text{Diameter of drive pulley} & - & 14 \text{ inches} \\
 \text{Diameter of driven pulley} & - & 36 \text{ inches} \\
 \text{Saw speed} & = & \frac{1,800 \times 14}{36} = 700 \text{ r.p.m.}
 \end{array}$$

## MILL FOUNDATION

Without a solid foundation, mill equipment cannot remain aligned and in correct adjustment. The mill foundation, as with other mill machinery, must receive regular maintenance to assure its proper performance.

Maintenance of a mill foundation made with wood should include checking for rotted and weakened pieces. Partially rotted wood loses its strength and capability to withstand stress. As pieces weaken, the mill begins to sag and carriage travel runs offline, making it impossible to cut accurate lumber.

Probing around foundation members with a sharp pointed instrument quickly discloses deteriorated wood. Any piece suspected of containing rot should be replaced.

Mill foundations made from wooden pieces must come into direct contact with a source of moisture for rot to develop. Occasional wetting by rain and atmospheric humidity does not generally provide sufficient moisture for wood to deteriorate. Mill debris and especially wet sawdust, if allowed to accumulate, becomes an excellent moisture harboring agent. This debris should be removed regularly from around the mill foundation.

Other maintenance of the foundation should include checking for shifting members, especially in areas where a great deal of stress is placed, such as around the husk. Loose bracing eventually allows all foundation members to shift, resulting in unsatisfactory mill performance. A periodic check should be made of all bolts, bracing, wire, turnbuckles and other fasteners to insure that they are in place and secure.

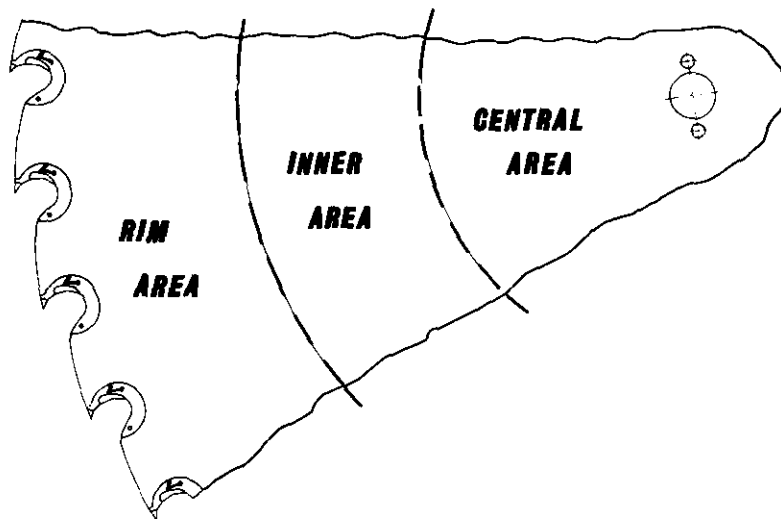

Figure 27. – The three areas of a saw plate involved in tensioning a saw.

## HEADSAW

The upkeep of the headsaw is one of the most crucial tasks in sawmill maintenance. Maintaining the saw not only includes keeping the teeth sharp and in shape but keeping a close check on the condition of the plate as well. A saw must possess the correct amount of tension to work properly. It must also remain free from kinks or twist. Saw teeth should be sharpened correctly once or twice a day depending on the condition of the logs and the amount of daily production. Dull saws run hard, consume extra power, become hot, and cut poor lumber.

### SAW TENSION

Saw tension refers to the prestretching of the inner area of the plate (fig. 27). This prestretching of the inner area produces a state of tension in the rim area. To work best, a saw must be tensioned properly for the speed at which it turns while in the cut (fig. 28). Most mills do not tension their own saws; they have it done by experts who are properly equipped to do the job.

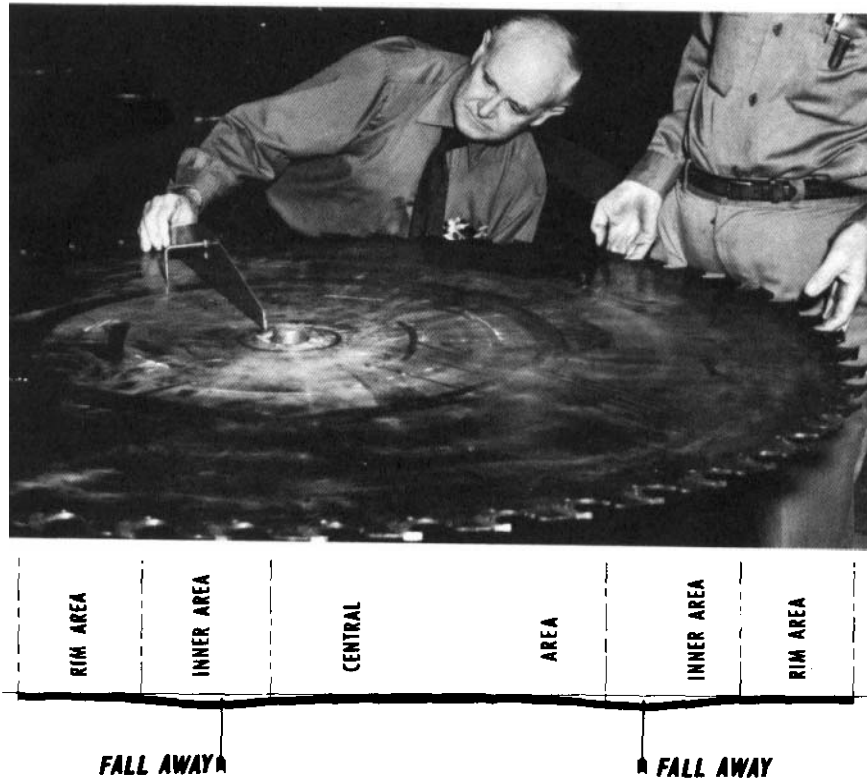

Figure 28. —A tension gage is used to measure amount of fall away (tension) in a circular saw.

Rotational stresses and heating at the tooth zone act upon the saw during normal operation causing the steel to stretch more in the rim area than in the inner area. Heating at the tooth zone is caused by friction in cutting and sawdust is restrained by the adjacent, cooler metal. This puts the rim in a state of compression. If the steel in these two areas is not in a state of stress equilibrium at operating speed, the saw tends to buckle and weave and will not stand up straight nor cut a straight line (fig. 29).

In Figure 29A, the profile is that of a saw that is turning at its tensioned speed. The tension forces acting upon the saw are in "balance."

In Figure 29B, the profile is that of an "open" or "loose" saw. It has excessive dish, meaning that the central area is too large or contains too much tension. The rim is too short and is, therefore, put into tension. This saw tends to heat in the center.

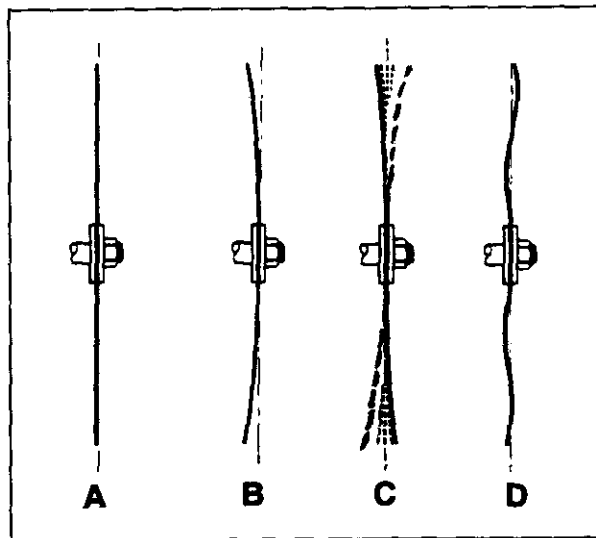

Figure 29.—Profile of a saw plate as affected by tendon.

In Figure 29C, the profile illustrates a "fast" saw. The rim is too long for the inner area and is in compression. The central area needs to be larger. This saw tends to heat in the rim.

In Figure 29D, the profile shows uneven tension. Here we have annular areas alternately tight and loose. Such a saw will perform erratically.

Saws are generally tensioned by a hammering process. In addition to being tensioned, a saw must be leveled to a state of flatness; i.e., free as possible from high spots and kinks or twist. Tensioning and leveling must be achieved simultaneously during the hammering process by specialists who are trained and equipped to do the job properly.

Excess heat affects tension in a saw plate. When inspecting a saw suspected of possessing improper tension, always check for a heated plate. A saw that is functioning properly should run very little warmer than the surrounding air temperature.

Several factors govern the amount of tension hammered into saws: dieter; gage, saw speed, number of teeth, kind of wood sawn, horsepower available, and

carriage speed. In general, larger, thinner, faster, and more heavily loaded saws require more tension than when the opposite is true.

Saws that run at a speed of 650 r.p.m. or less should remain flat on the log side when mounted on the arbor and when stationary. This flatness can be checked easily with a machined straightedge (fig. 30). If the log side is not flat, the collars may be defective or the saw may be sprung or twisted and need hammering. Saws that turn faster than 650 r.p.m. or exceptionally thin saws may exhibit a slight dish when stationary after they are hung on the arbor.

Symptoms of a sprung saw are a chattering at the guide pins and a tendency to heat. However, these symptoms could also indicate a sprung arbor. A simple test can be made to distinguish between a sprung saw arbor and a sprung or twisted saw. First, set the guide pins equidistant from the saw. Rotate the saw until it makes contact with either guide pin. Remove the collar and rotate saw 180 degrees (the arbor must remain stationary) then replace collar and arbor nut and tighten with a wrench in the normal manner again without moving the saw. Now recheck the saw in relation to the guide pins. If it contacts the same pin as before, the **arbor** may be sprung; if it contacts the opposite pin, the **saw** may be sprung or twisted.



*Figure 30.—Check log side of the saw for flatness with a machined straightedge.*

#### SAW TEETH MAINTENANCE

Inserted saw teeth assemblies are comprised of two parts – the bit and shank – and when inserted in place perform as a single unit (fig. 31). Saw teeth can function properly only when they are correctly installed and maintained.

After inserting the bit and shank correctly, seat the shank into place by striking it with a firm blow as shown in figure 32. Next, bring the swage of the shank into exact alignment with the bit. To do this, hold a metal bat on one side of the bit and using a hammer or bar tap lightly on the opposite side of the shank until each is aligned with the other. Failure to align the bit and shank results in poor saw operation and a wider kerf, which needlessly increases power consumption.

Whenever saw teeth are removed, thoroughly clean the socket and the “V” in the bit and shank and apply oil or kerosene to prevent corrosion and excessive wear while reinserting.

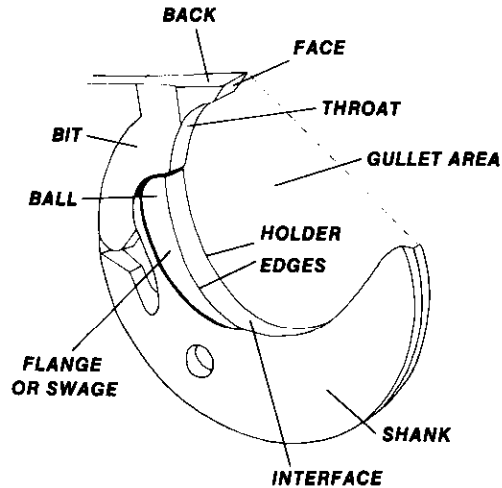

Figure 31.—Parts of an inserted sawtooth.

Regular upkeep on saw teeth includes maintaining proper shank condition, uniform length and width of teeth, correct tooth angle, sharp cutting edge and tooth corners, and proper swage.

Shank condition. — Shanks perform two equally important functions: (1) to hold saw bits in place, and (2) to chamber and remove sawdust from the cut.

To fit properly, a shank must be slightly larger than its socket so that in place it acts as a spring in maintaining pressure on the bit. As a result, a substantial amount of tension (compression of steel) is imparted **to** the saw rim. As shanks



Figure 32. — Seat shanks in place by striking them with a firm blow.

wear they become loose in their sockets and cannot provide sufficient pressure for the bits or tension for the saw plate; the saw in this case usually appears to need hammering. Worn shanks without sufficient spring to hold the bits in place can be stretched by peening as shown in figure 33. However, when shanks become this worn, it is usually best to replace them with new ones. Be sure to check saw tension whenever new shanks or newly peened shanks are put into the saw.

Shanks are manufactured with a flange, or swage, about 1-1/2 to 2 gages thicker than the saw plate to reduce the amount of sawdust slipping out of the gullet and to prevent excessive contact with the wood. Shanks with worn flanges and rounded edges will allow sawdust to slip out of the gullet, thus accelerating wear on the gullet edges as well as the saw plate (fig. 34). Sawdust spilling out of the gullets also causes the rim area to heat. Shanks with rounded edges but in otherwise good condition can be restored to their original shape by sharpening straight across the interface.

**Uniform saw teeth.** – All saw teeth should be uniform in length after sharpening, which is best accomplished by using an electric saw grinder similar to that shown in figure 35. A good hand filer can do a creditable job of sharpening saw teeth, but he cannot equal the speed and the accuracy possible with a mechanical grinder. When both short and long teeth are present in a saw, the

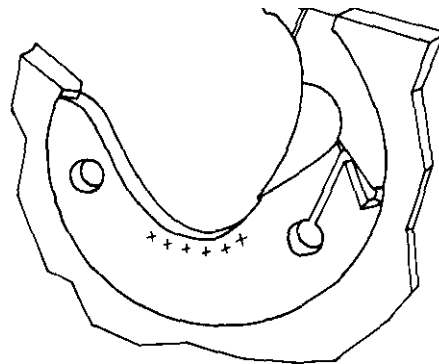

Figure 33—Stretch loose shanks to a tighter fit by peening them on both sides at the points indicated,

longer teeth carry the brunt of the sawing load thus setting up unequal working stresses in the saw that can result in erratic operation. When replacing damaged teeth in a saw, sharpen newly inserted teeth to the length of the existing ones.

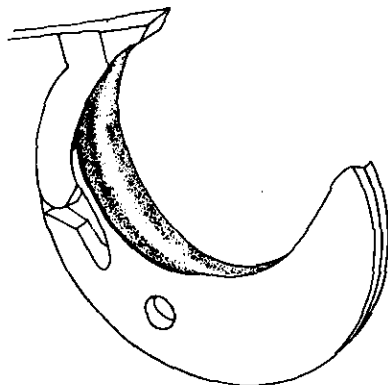
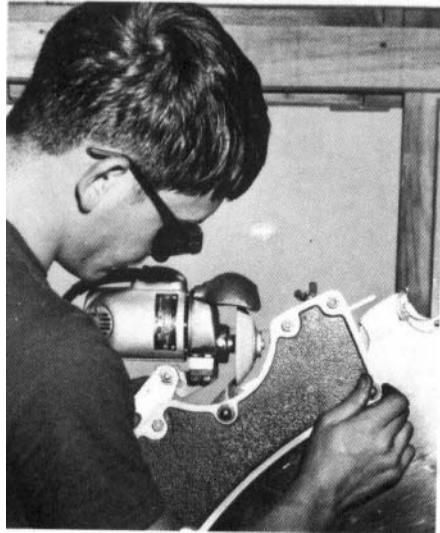
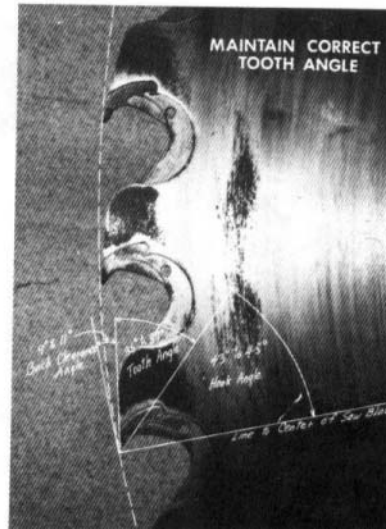

Figure 34.—Shank flanges eventually wear round and allow sawdust to slip out of the gullet. Restore them to their original shape by sharpening straight across the interface.

**Saw tooth angle.** The original tooth angle should be maintained in the sharpening process. If the tooth angle becomes greater than about 40 degrees, carriage feed is restrained and additional power is consumed. A tooth angle less than about 30 degrees weakens the cutting edge, often resulting in crumbling. The original tooth angle of 35 to 37 degrees of most saw teeth, if maintained,



*Figure 35. – An experienced operator can sharpen inserted sawteeth with an electric grinder in 3 to 5 minutes*



*Figure 36. – For good saw performance, the tooth angle should be maintained between 35 to 37 degrees.*

assures good saw performance (fig. 36). Gages are available for checking the tooth angle (fig. 37). A simple though somewhat less effective way to measure the tooth angle is to hold a new tooth alongside the one to be checked and compare their similarity. When using mechanical grinders for sharpening teeth, insert a new tooth in the saw and use it as a gage in setting the angle of the cutting wheel.

**Cutting edge.** – Normally, a sawtooth is sharpened only on the face (fig. 38). The cutting edge should be maintained by filing or grinding back the face in a plane parallel to the original face. Some millmen prefer to renew the cutting edge by filing on the top side of the tooth as well as on the face. However, excessive top filing lowers the cutting edge and decreases the top clearance angle (fig. 39). If this angle is decreased below 3 to 4 degrees it may result in the backs of saw teeth rubbing the cant and inhibiting carriage feed. Saw teeth are designed so that as the face is sharpened, the receding cutting edge remains very nearly a constant distance from the center of the saw.



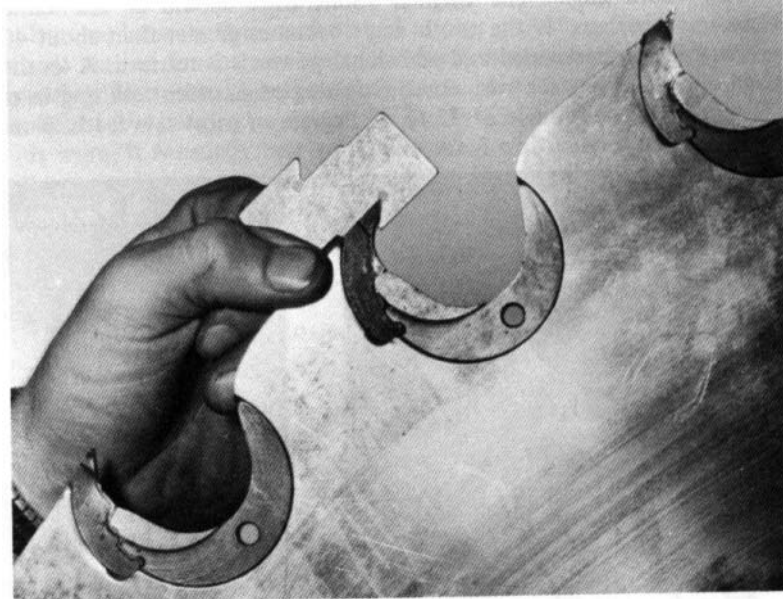

Figure 37. – Tooth angle can be checked easily with a tooth angle gage.

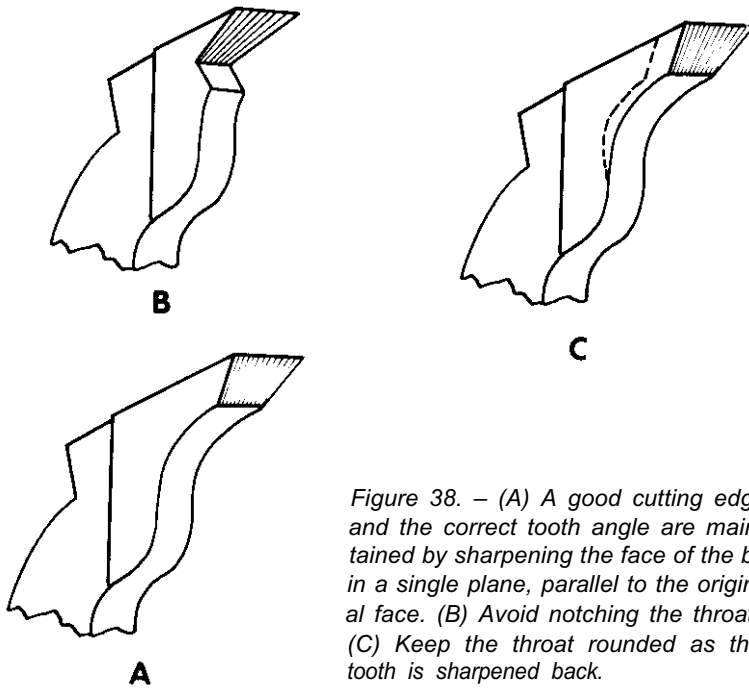

Figure 38. – (A) A good cutting edge and the correct tooth angle are maintained by sharpening the face of the bit in a single plane, parallel to the original face. (B) Avoid notching the throat. (C) Keep the throat rounded as the tooth is sharpened back.

Sharpening saw teeth at an angle instead of straight across results in a high corner and the saw will naturally lead to that side. Sharpening the face in two planes varying by 8 degrees or more results in the saw pulling hard and consuming additional power (fig. 40). Sharpening with a rounded face reduces side clearance and may result in the saw wandering and heating.

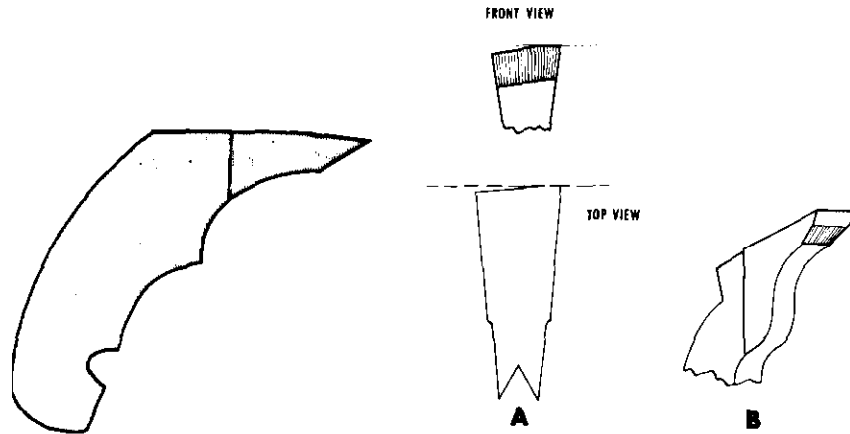

Figure 39. – Avoid excessive top filing as it lowers the cutting edge and reduces top clearance, thereby inhibiting carriage feed and increasing power consumption.

Figure 40.–(A) Avoid sharpening the bit at an angle instead of straight across as it causes the saw to lead to the high corner. (B) Avoid sharpening the bit in a 2-plane bevel as it results in the saw pulling hard and consuming additional power.

**Swage.** – The cutting edge of a saw tooth must be spread wide enough to provide clearance for the saw plate. If the swage is uneven (fig. 41) or too narrow, the saw will rub the cant resulting in a heated plate.

As saw teeth wear or become damaged they may need swaging to restore the cutting edge to its original width. An upset swage is used for this purpose (fig. 42). Utmost care must be exercised in using this swage. Striking it too hard may damage the sockets by spreading them open. Correct procedure in using this swage requires striking steady, light blows with a hammer weighing not over 1 pound.

Before swaging is attempted, first sharpen the saw teeth. Then using the die with the convex face, spread both corners of the tooth. Next, square the cutting edge using the die with the straight face. Be sure to center the die on the tooth in each case. Also, be sure to position the swage correctly as either a too high or too low placement will result in altering the location of the cutting edge. Altering the location of the cutting edge affects the tooth angles which changes the feeding characteristics of the saw.

Saw teeth comers should be brought to a uniform gage and distance from the plate. To do this, use a side dresser file and gage to properly re-establish the

width of the tooth. Then side file to re-establish clearance for the face width of the tooth.

Saw teeth should not be swaged more than necessary. Each 1/32 inch of excessive swage increases power consumption by about 11 percent and reduces potential lumber volume by more than 2 percent on 4/4 stock.

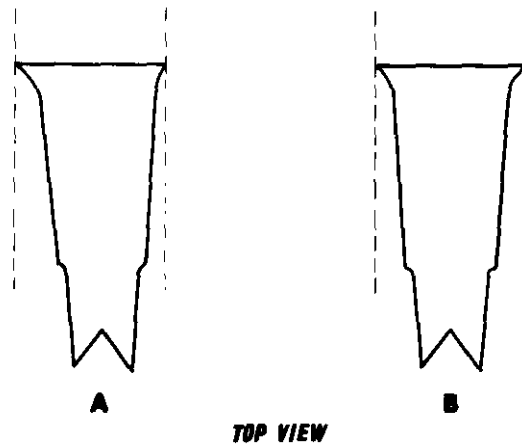

Figure 41. – (A) A void swaging heavy to one side as it causes the saw to lead to that side. (B) Swaging teeth evenly on both sides helps assure good saw performance.



Figure 42. – Proper swaging requires positioning, holding, and striking the swage correctly.

## PULLEYS AND V-BELTS

Pulleys and belts can be damaged by improper handling and care. Grooves on the pulleys can be easily nicked or burred if they are carelessly handled or left lying around, and these seemingly small nicks or burrs can quickly ruin new belts.

Hanging belts so that they bend more sharply than the pulleys on which they run can weaken them and thus reduce their life expectancy. Exposing belts to extremely high temperatures and sunlight can also have damaging effects.

Power cannot be transmitted effectively if pulleys and belts are not maintained properly. Maintenance should include checking for pulley damage and wear; unevenly stretched belts; incorrect belt tension; and pulley misalignment.

Most nicks or burrs on the grooves can be removed with a file or emery wheel. Excessively worn grooves allow the belts to ride the bottom of the grooves rather than the sides, which shortens belt life and reduces power transmission capability. When this condition exists, belts often are over-tensioned to keep them from slipping. This also overloads the bearings thus shortening their life as well.

V-belts should always be used as matched sets. This helps insure that belts will stretch evenly as normal wear progresses. It also assures even load distribution. When belts of uneven length are used the load is borne mainly by those that are tight; thus available power cannot then be effectively transmitted without belt slippage occurring. This results in greatly reduced belt and pulley life, loss of shaft speed and poor saw performance.



*Figure 43. – Check for proper belt tension with a V-belt tension tester.*

A new V-belt should never be used as a replacement in a used set. If a V-belt breaks and no replacements are available from a similar used set, it is usually best to completely replace the old set. Belts from the old set can then be used as future replacements.

Correct V-belt tension must be maintained. V-belts can be overtightened to the point where they cause excessive bearing loads, which shortens both bearing and belt life considerably. New V-belts stretch more during the first few days of operation than during the rest of their useful life. For this reason they should be checked for proper tension several times during the first few days of operation and weekly thereafter.

Normally, considerable effort is required to twist a properly tensioned V-belt a half-turn. This should be tested by hand about midway in the span between the two pulleys. A more precise method of checking belt tension is to use a V-belt tension tester, as shown in figure 43. The following example shows the procedure recommended by one manufacturer for using such a tester (refer to fig. 44):

1. Measure the span,  $K$  (center distance), between the two pulleys.
2. Compute the distance ( $D$ ) the V-belt should deflect at the center of the span, at the rate of .0156 inch per inch of span. Refer to table 18 for the amount of force ( $F$ ) required to deflect the belt this amount.
3. Use a V-belt tension tester to obtain values for the belts in question.

Adjust belts for correct tension to obtain the values computed in step 2.

Misaligned pulleys can shorten belt life considerably and reduce power transmission capability. Pulley alignment can be checked by stretching a string between the pulleys near their centers, touching the outer edge of each (fig. 45).

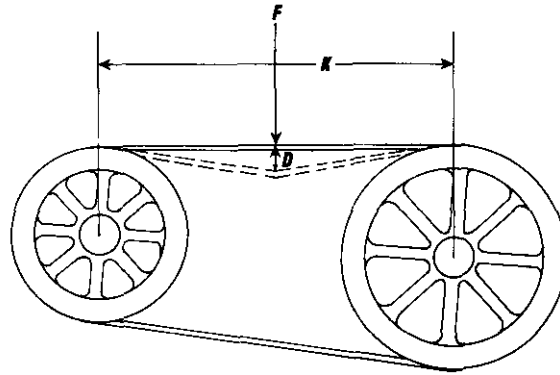

Figure 44. – With proper tension, V-belts should deflect distance  $D$ , computed at .0156 inch per inch of span  $K$ . The required force,  $F$ , to deflect the belt this amount is shown in table 18.

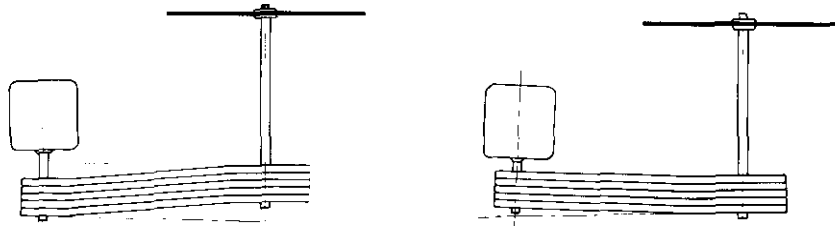

Figure 45. – Two common cases of pulley misalignment. Check pulley alignment with a string stretched alongside the pulleys near their centers.

Table 18. – Recommended deflection force for given V-belt sizes<sup>1</sup>

| V-belt size | Minimum force                      | Maximum force |
|-------------|------------------------------------|---------------|
|             | -- -- -- -- --pounds-- -- -- -- -- |               |
| A           | 2                                  | 2-3/4         |
| B           | 4                                  | 5-1/2         |
| C           | 8-3/4                              | 12            |
| D           | 17                                 | 33            |
| E           | 26-1/2                             | 31            |

<sup>1</sup> Data from catalog of Dodge Mfg. Corp. of Mishawaka, Ind.

### SAW ARBOR

With a saw in apparently good condition but performing unsatisfactorily, the trouble could be in a sprung or twisted arbor. A saw cannot run true unless the arbor is perfectly straight.

#### TESTING FOR DEFECTIVE ARBOR

Symptoms of a sprung arbor are chattering of the saw at the guide pins, excessive heating of the saw on the rim, and heating of arbor bearings beyond normal limits. These symptoms may arise from other sources and, for this reason, troubleshooting the arbor often is difficult.

Before testing for a sprung arbor, be sure it is free from end play, saw tension is correct, and saw collars are true and in good condition. Refer to page 54 and the test on how to distinguish between a sprung arbor and a sprung saw. A dial test indicator can also be used to test an arbor suspected of being sprung.

#### MAINTENANCE REQUIRED

Regular and systematic maintenance of the arbor should include checking for level, proper running temperature of the bearings, and end play. The bearings should receive lubrication regularly.

Test the arbor for level after a saw has been subjected to severe shock. Do

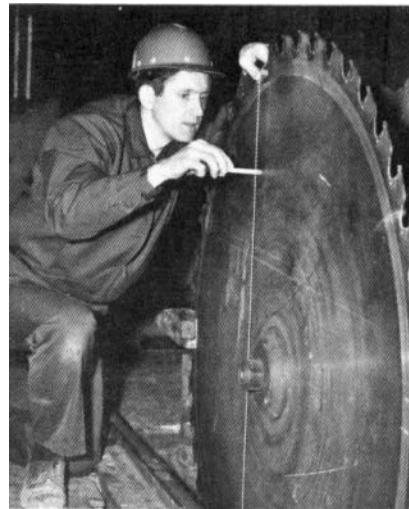

Figure 46. Check saw for plumb by dropping a bob alongside and measuring at various places along the line.

this by checking the saw for plumb; if the saw is plumb, the arbor will be level (fig 46.) Be sure the saw, saw collars, and arbor are all in good condition when making this test. An unlevel arbor can result from heavy rains or frost heave, both of which cause unstable soil conditions and settling of the husk. Constant sawing stresses also tend to shift the husk. Use a high quality machinist's level to level the arbor (as discussed in Equipment Setup) as most carpenter's levels will not give sufficiently accurate readings.

Arbor bearings should run at "normal" temperature, which must be established for each mill setup. Generally, bearings should not run much warmer than body temperature or about 100 degrees F. If above-normal temperatures are detected with the bare hand, the bearings can be suspected of being defective or improperly maintained. However, perfectly good bearings can heat up from other sources such as a heated saw. This heat will transfer back through the arbor to the bearings. Be sure to establish the source of heat before deciding whether the saw or the bearings are at fault.

The bearing next to the saw often runs slightly warmer than the others because of greater stress imposed by sawing. This is normal, and if the tendency is to run consistently warm be sure to take it into account when having the saw tensioned. Do not allow the bearing next to the saw to overheat severely because this upsets saw tension. As heat is detrimental to good saw performance, the bearing next to the saw should not be allowed to run much warmer than is comfortable to the hand.

Check mounting bolts on the arbor bearings weekly because they have a tendency to loosen from normal operation. Keeping bolts tight will help prevent end play from developing in the arbor.

Arbor bearings must receive proper lubrication for trouble-free saw operation. Overlubrication as well as underlubrication generally results in unsatisfactory performance. Manufacturer's recommendations regarding amount and interval of lubrication should be closely followed.

## **SAW COLLARS**

Defective saw collars can be another cause of an improperly running saw. They cause the saw to behave much the same as if a defective arbor were the problem. Visual inspection alone does not always reveal collar damage, although nicks or burrs on the bearing surfaces are usually strong indicators.

### **TESTING FOR DEFECTIVE COLLARS**

A quick test for defective saw collars can be made with the saw and collars mounted in their normal position. First free the guide pins from the saw, then loosen the arbor nut and retighten by hand only. Next, reset the guide pins equidistant from the saw and tighten the arbor nut with a wrench in the normal manner. Now recheck the guide pins. If the saw remains equidistant from the pins, the collars are probably all right, if the saw has moved toward either pin, one or both collars may be defective.

A dial test indicator can be used to check the fast collar for trueness (fig. 47). A collar that deviates more than .002 to .003 inch in one rotation needs to be



*Figure 47.—Check the fast saw collar for trueness with a dial test indicator. A collar that deviates by more than .002 to .003 inch per revolution needs to be remachined.*

remachined. Even though the amount the collar is off may seem small it is magnified several times at the rim of the saw. Before deciding that the collar is defective be sure the arbor itself is true.

A chalk test can reveal the taper condition of the bearing surfaces of the collars (fig. 48). Apply a generous amount of caked chalk to the bearing surfaces of each collar. Then scrape across the full face of the collar with a machined straight edge. If only the chalk on the outer edge of the bearing surface is removed, the taper is probably all right; if nearly all the chalk is removed from the full width of the bearing surface the collar probably contains little or no taper. Removing only the chalk on the inside of the bearing surface means that collar taper is actually reversed. Collars in such condition cannot provide proper support for the saw.

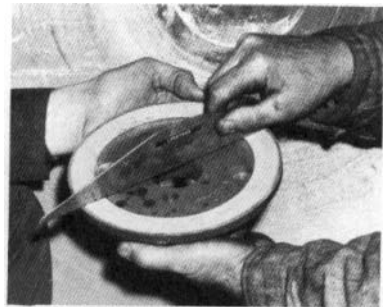

**B**

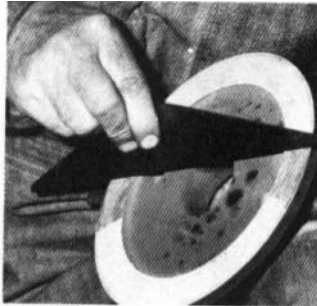

**C**



**A**

*Figure 48. — Test for taper condition of saw collar by the following 3-step process: (A) first chalk the bearing surface. (B) scrape a machined straight-edge across the full face of the collar; if chalk is removed from the outer edge only, taper is all right. (C) if chalk is removed the full width of the bearing surface, taper is lacking.*



## MAINTENANCE REQUIRED

Saw collars rarely wear out and can run trouble-free for years provided they are not abused. Despite their heavy appearance, however, collars can be damaged quite easily if the mill is not operated with care.

Overheating perhaps causes the greatest damage to collars. For example, the intense heat that develops when a saw hangs and the arbor and fast collar continue to turn against the jammed saw may seriously damage the collars by warping them. When this happens, the nut is tightened with all the force and inertia of the power unit and pulley system and frequently presses all concavity out of the collars. Resulting friction rapidly turns to heat even when it lasts for only a second or two. The heat may become so intense that it melts the metal and ruins the collars or the saw or both. If saw collars become severely overheated or a saw hangs and the lug pins are sheared, check the collars immediately for damage. Otherwise, check them regularly once a week.

## CARRIAGE AND TRACKS

For the carriage and track components to be maintained properly, headblock-knee assemblies must be kept aligned; trucks must be kept free from end-play, setworks must be kept tight, dogs must be kept sharp and in good working order, and tracks must be kept level and aligned.

## HEADBLOCK-KNEE ASSEMBLY

To cut accurate lumber, headblocks must remain level (fig. 49) and all knees must be kept in alignment. Check knee alignment by stretching a string across



*Figure 49. – Check the headblock base with a high quality machinist's level.*

the knee faces (fig. 50). Provision is made on most carriages for adjusting the knees for correct alignment (fig. 51).

Sometimes the knees get out of time when they are receded too far and the racks and pinion gears become disengaged. They must be simultaneously re-engaged, which requires a person on each knee.

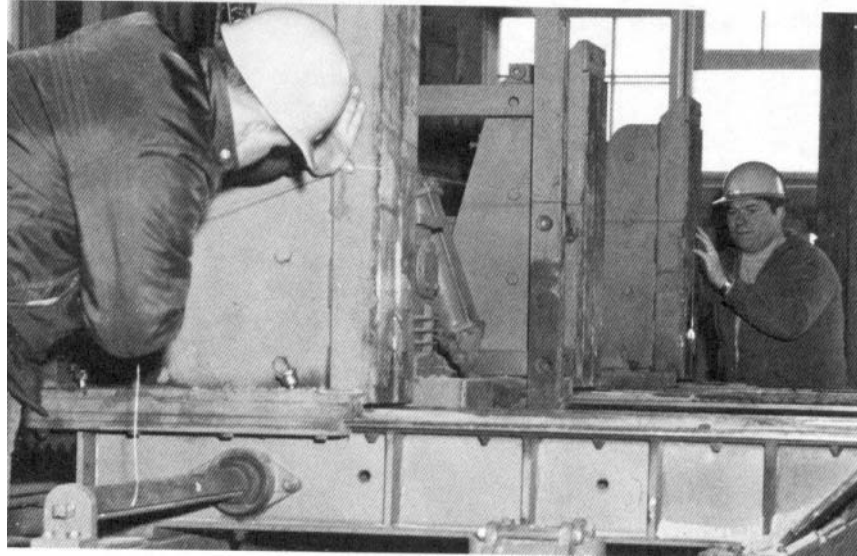

*Figure 50. – Stretch a string across knee faces to check knee alignment.*



*Figure 51. – Most carriages make provision for adjusting knee alignment. On this carriage with chain driven knees, knee alignment is changed by loosening one of these nuts and tightening the other.*

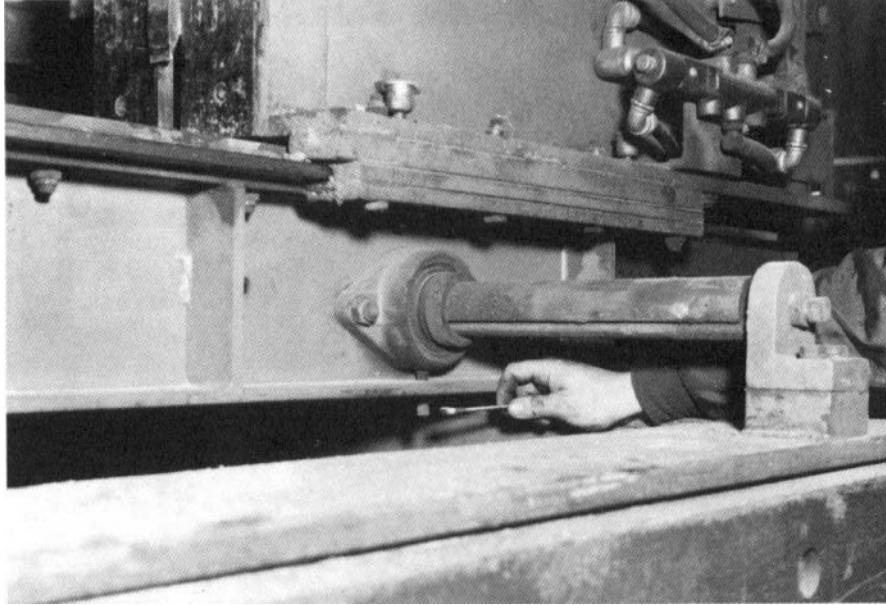

*Figure 52. – Adjust the set shaft for a proper mesh between the rack and pinion gear by raising the bearing with the set screw on the underneath side, Bolts that hold these bearings in place must be loosened before making the adjustment and retightened after.*

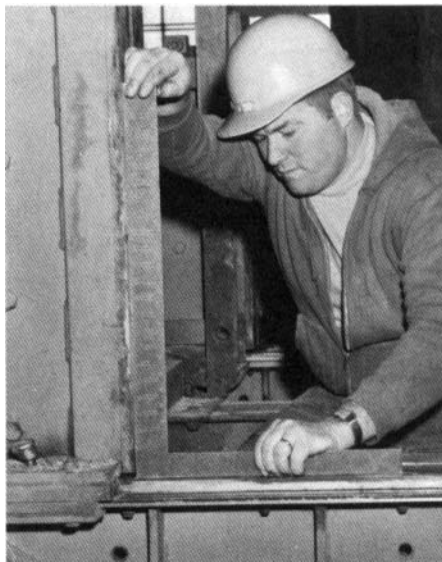

*Figure 53.–Check the knee and head-block base for a 90-degree angle with a carpenter's square.*

Backlash sometimes occurs when slack develops between the rack and pinion gear. Worn bearings, loosely mounted bearings, wear in the key and key-ways, and wear on the gears and racks themselves can all contribute to backlash. On carriages with chain driven knees, the chains can become slack and result in backlash, also.

To test the knees for backlash, grip the upright and apply a quick forward and backward motion parallel to the base of the knee. Movement of the knee of more than about 1/16 inch means that adjustment is required. Check all bearings for wear and be sure that all bearings and mounts are tight. If slack remains, raise the setshaft to a snug fit between the racks and pinion gears (fig. 52). Carriages with chain drives also are equipped with adjusting devices for taking out slack.

The front face of the knees should

form a 90-degree angle with the headblock bases (fig. 53). Excessive wear on either the knee face or the headblock bearing surface can alter this angle. If the carriage is equipped with replaceable wear plates, simply reverse or replace them as the need may be. These wear plates have a tendency to work loose and should be checked periodically. On older carriages not equipped with wear plates, excessively worn knee faces and headblock bearing faces should be rebuilt, remachined, or replaced.

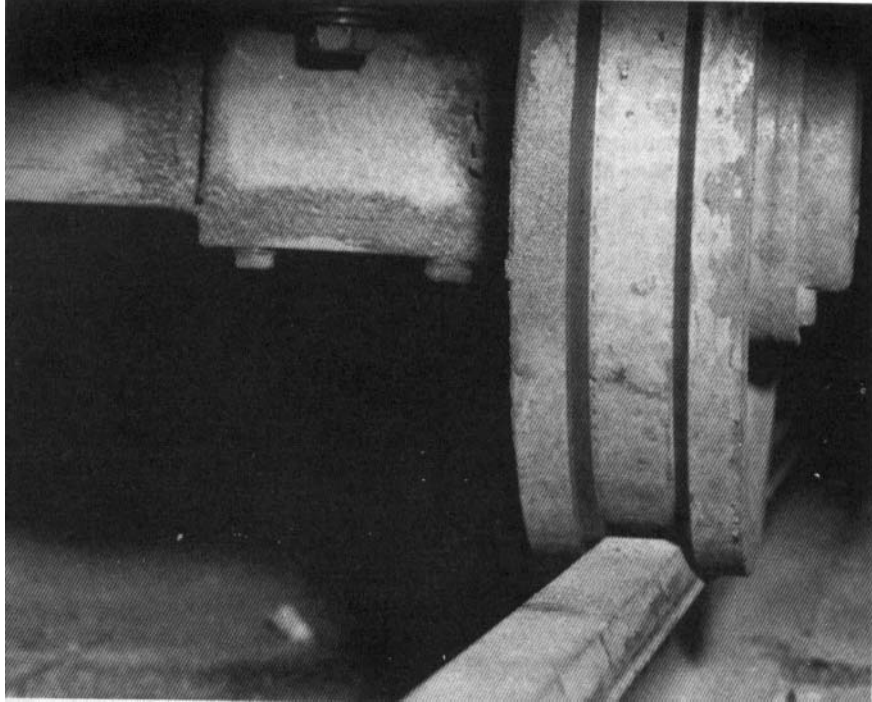

*Figure 54. – A proper fit between the guide wheel and rail is evidenced by the wheel riding the bevel of the rail without the bottom of the wheel and the top of the rail making contact.*

## **TRUCKS**

Trucks with end play will allow sideward movement of the carriage that could result in mismanufactured lumber. Check for end play by giving the carriage a hefty sideways shove (use a pry bar with a heavy carriage). Any movement detected should be eliminated by tightening the collars on the guide-wheel axles. Be sure that all bearings and bearing mounts are tight.

The guide track and guide wheels should be inspected periodically for excessive wear. A proper fit between the wheels and the rail is essential for straight line carriage travel past the saw. The flanges of the wheels should ride the beveled sides of the rail. A proper fit between the guide rail and the guide wheels is evidenced by daylight visible between the top surface of the track and the bottom surface of the “V” in the wheel (fig. 54). When these two surfaces

meet and begin to wear, the guide wheels should be either remachined or replaced.

Track cleaners should be checked occasionally to insure they are doing their job. Gum and resin deposits that collect on the tracks should be removed to prevent the carriage from humping at these spots.

## **SETWORKS**

Slack in the setworks caused by wear on the ratchet wheel teeth, pawls, and pawl wheel carrier pin, and play in the keys and key-way of the ratchet wheel and set shaft can result in inaccurate settings. Slack in the roller chains on carriages so equipped leads to the same result. To test the capability of a setworks to set accurately, use first a large and then a small cant starting at a known point on a run and check each setting on the scale board down to the last board sawn. Assuming the saw is functioning normally, the carriage trucks are tight, and there is no backlash in the setshaft mechanism, this test should determine if the setworks is setting consistently within 1/32 inch of that desired. If this tolerance is not attained check setworks for causes of error.

The setting error on each board might seem small, but the cumulative effect can add up to a sizeable amount in the dog board. For this reason the setworks must be in top condition to help assure that each board measurement is as close as possible to the desired target set.

Excessively worn ratchet wheels, pawls, pawl wheel carrier pins, and keys should be replaced. All working parts must fit tight, work smoothly, and should be lubricated regularly.

## **DOGS**

The dogs must be kept sharp and in good working order to hold logs or cants securely while being sawed. Inadequately dogged logs or cants can spring back against the saw, forcing it out of line or causing it to heat. In extreme cases, the saw can become kinked or throw a log or cant back at the sawyer, thus endangering his personal safety.

## **TRACKS**

Tracks must remain level and the guide track aligned so that the carriage can travel in a single plane and in a straight line past the saw. Tracks that twist, bow, or sag will permit the carriage to travel off line, resulting in inaccurately cut lumber and saw problems.

Regular maintenance of the track should include checking for alignment (as discussed in Equipment Setup). Stretch a cord or fine piano wire about 1/4 inch above and then alongside the track in the area where the carriage travels while the log is in the saw. Adjust the track at points where deviation from the line occurs.

Tracks should be crossleveled to insure that the carriage travels in a single plane. Any twisting motion of the carriage while the log is in the saw will result

in mismanufactured lumber and saw problems. One way to check the tracks for crosslevel is to load a large log on the carriage and, with a level mounted crosswise on the carriage, run the carriage slowly down the track and be especially careful to note any movement of the bubble in the vicinity of the husk.

## GUIDE FOR TROUBLESHOOTING

If it were possible to set forth a cause and effect relationship to locate operating difficulties, trouble-shooting a mill would be an easy matter. Such is not the case. The effects or symptoms of trouble often arise from any one of a number of possible causes, but more often from a combination of causes. Therefore, trouble-shooting a sawmill often becomes a difficult task.

The old adage that an ounce of prevention is worth a pound of cure certainly applies in the sawmill. To keep a mill running in top condition requires continual maintenance to insure that every piece of equipment functions as intended. Every mill sooner or later experiences sawing difficulties unless preventative maintenance is practiced daily. The following list may help locate some of the causes of the more common problems found at one time or another in nearly every sawmill.

| Symptom   | Possible causes   |
|---|---|
| Excessive variation in thickness between boards, other than dog board | <ul style="list-style-type: none"> <li>(1) Setworks inaccurate</li> <li>(4) Backlash between pinions on set shaft and racks</li> <li>(3) Shanks worn</li> <li>(4) Saw bits dull</li> <li>(5) Saw speed fluctuating by more than 10 percent</li> <li>(6) Husk not fastened securely to foundation</li> <li>(7) Scale setting incorrect</li> <li>(8) Dogging inadequate</li> <li>(9) Swage of cutting edge on saw teeth too narrow</li> <li>(10) Play between guide wheels and carriage</li> <li>(11) Saw tension incorrect for speed of saw</li> <li>(12) Saw guide adjusted improperly</li> <li>(13) Carriage speed too slow</li> </ul> |

| <b>Symptom</b>  | <b>Possible causes</b>   |
|---|--|
| Dog board wedge-shaped, edge to edge                        | <ul style="list-style-type: none"> <li>(1) Faulty knee alignment</li> <li>(2) Tracks or headblocks unlevel</li> <li>(3) Saw “open” if top of board is thicker than the bottom, saw “fast” if top of board is thinner than the bottom</li> <li>(4) Bottom dog inoperative</li> <li>(5) Headblock bases worn near outer ends</li> </ul>  |
| Dog board wedge-shaped, or varies in thickness, end to end. | <ul style="list-style-type: none"> <li>(1) Saw logs springy</li> <li>(2) Twist or dip in track</li> <li>(3) Side play in carriage trucks</li> <li>(4) Faulty knee alignment</li> <li>(5) End play in arbor (babbit bearings only)</li> <li>(6) Inadequate saw upkeep</li> <li>(7) Saw collars defective</li> <li>(8) Saw dished at operating speed</li> <li>(9) Excessive lead if back end of board is thin</li> <li>(10) Insufficient lead if back end is thick</li> </ul>  |
| Saw heats in the rim area                                   | <ul style="list-style-type: none"> <li>(1) Excessive lead</li> <li>(2) Saw speed excessive</li> <li>(3) Either or both guide pins too close to the saw</li> <li>(4) Insufficient tooth swage</li> <li>(5) Flanges on the shanks worn</li> <li>(6) Insufficient gullet capacity for the size of logs being sawn and the carriage speed being maintained</li> <li>(7) Arbor sprung</li> <li>(8) Saw dished into the log</li> <li>(9) Collars improperly fitted</li> <li>(10) Saw tensioned for a slower speed than that being run</li> <li>(11) Bite too small - sawdust slipping out of the gullet</li> </ul> |

| <b>Symptom</b>                                     | <b>Possible causes</b>   |
|--|--|
| Saw heats in the inner area                        | <ul style="list-style-type: none"> <li>(1) Insufficient lead</li> <li>(2) Arbor bearing next to the saw running hot</li> <li>(3) Saw turning slower than the speed for which it was hammered</li> <li>(4) Saw dished away from the log</li> <li>(5) Bearing next to the saw collar loose</li> <li>(6) Saw being run with dull teeth</li> </ul>   |
| Saw throws sawdust from the back                   | <ul style="list-style-type: none"> <li>(1) Shanks worn</li> <li>(2) Bits and shanks not aligned properly</li> <li>(3) Carriage speed too slow</li> <li>(4) Play between guide wheels and carriage</li> <li>(5) Insufficient lead</li> <li>(6) Saw teeth dull</li> <li>(7) Rim, inner, and central areas of saw being run at uneven temperatures</li> </ul>   |
| Saw hammers, pounds, or chatters at the guide pins | <ul style="list-style-type: none"> <li>(1) Saw hung improperly</li> <li>(2) Saw collars defective</li> <li>(3) Saw speed fluctuates</li> <li>(4) Saw running hot</li> <li>(5) Arbor, saw or collars sprung</li> <li>(6) Drive or driven pulley out of balance</li> <li>(7) End play in arbor (babbit bearings only)</li> <li>(8) Bearings loose in their mountings on the husk</li> <li>(9) Saw out of round</li> <li>(10) Arbor shaft loose in bearing saddles</li> <li>(11) Saw is "fast"</li> </ul> |



| <b>Symptom</b>                          | <b>Possible causes</b>  |
|---|---|
| Saw cracks over the collar              | <ul style="list-style-type: none"> <li>(1) Saw not tensioned for the speed at which it operates</li> <li>(2) Collars defective</li> <li>(3) Saw hung improperly</li> <li>(4) Side play in carriage trucks</li> <li>(5) Foundation weak, especially in the area of the husk</li> <li>(6) Insufficient lead (saw running out of the log)</li> <li>(7) Saw teeth dull</li> <li>(8) Saw dished</li> </ul>   |
| Saw scores log on gig                   | <ul style="list-style-type: none"> <li>(1) Side play in carriage trucks</li> <li>(2) Track loose</li> <li>(3) Saw tensioned incorrectly for the speed at which it operates</li> <li>(4) Rim of the saw running hot</li> <li>(5) Insufficient lead</li> <li>(6) Saw teeth dull</li> </ul>  |
| Saw scam log while sawing               | <ul style="list-style-type: none"> <li>(1) Insufficient lead</li> <li>(2) Bits and shanks not aligned properly</li> <li>(3) Guide pins adjusted incorrectly</li> </ul>  |
| Saw has a tendency to lead into the log | <ul style="list-style-type: none"> <li>(1) Feeding too slow</li> <li>(2) Cutting edge of teeth sharpened into the log</li> <li>(3) Teeth swaged more on log side</li> <li>(4) Saw running hot in the rim area</li> <li>(5) Saw tensioned for a slower speed than which it is being operated</li> <li>(6) Excessive lead</li> <li>(7) Saw dished toward the log</li> <li>(8) Saw teeth damaged on board side</li> <li>(9) Shanks worn</li> </ul> |

**Symptom****Possible causes**

Saw has a tendency to lead out of the log

- (1) Feeding too fast
- (2) Cutting edge of teeth sharpened away from the log
- (3) Teeth swaged more on board side
- (4) Saw running hot in the inner area
- (5) Saw tensioned for a faster speed than which it is being operated
- (6) Saw teeth dull
- (7) Insufficient lead
- (8) Saw dished away from the log
- (9) Saw teeth damaged on log side

**CHECKLIST FOR PERIODIC MAINTENANCE**

| <b>Daily</b>                | <b>Weekly</b>  | <b>Monthly</b>                          |
|-----------------------------|--|---|
| Sawteeth wage and sharpness | saw – speed<br>– plumb <sup>1</sup><br>– flat, log side <sup>3</sup><br>– lead <sup>1</sup><br>– shanks <sup>2</sup> | Mill foundation                         |
| Arbor bearings (heating)    |  | Husk                                    |
| Drive belts                 |  | Saw guide (position) <sup>1</sup>       |
| Guide pins                  | saw collars <sup>2 3</sup>   | Spreader                                |
| Headsaw (heating)           | Lug pins <sup>2</sup>  | Saw arbor (straightness) <sup>2 3</sup> |
| Cleanup (debris, oil, etc.) | Carriage wheels; guide track   | Carriage – frame<br>– trucks<br>– dogs  |
| Machinery guards in place   | Headblock-knee assembly  |   |
|                             | Drive and driven pulleys   | Track cleaners                          |
|                             | Bolts (tightness)  | Pulleys                                 |
|                             | Belt tension   | Bracing                                 |
|                             | Setworks (set)   | Sprockets, chains                       |
|                             |  | Hydraulic hoses                         |

<sup>1</sup> Items to be checked after changing saws.

<sup>2</sup> Items to be checked after saw has been hung.

<sup>3</sup> Items to be checked after saw has been severely overheated.

## **BIBLIOGRAPHY**

## BIBLIOGRAPHY

- American Society of Mechanical Engineers  
1956. Handbook for small sawmill operators. 62 pp., illus. New York:  
Amer. Soc. Mech. Eng.
- Andrew, G.W.  
1958. Controlling your sawmill production. Can. Dep. North. Aff. &  
Nat. Resources, Forest Prod. Lab. Can., 5 pp., illus.
- \_\_\_\_\_ and Imada, T.F.  
1962. Suggested manufacturing tolerances in producing lumber. Can.  
Dep. Forest., Forest Prod. Res. Br. Rep. 185, 12 pp., illus.
- Applefield, Milton, and Bois, Paul J.  
1966. Thickness variation of hardwood lumber produced in 1963 by  
circular sawmills in North Carolina. Hardwood Res. Council. Rep.,  
5 pp., illus.
- Bell, G.E.  
1951. Gang-saw production higher in small log conversion. Can. Dep.  
North. Aff. & Nat. Resources, Forest. Br., 2 pp., illus.
- Bethel, James S.  
1955. Quality control in the manufacture of wood products. Forest  
Prod. J. 5(1): 45.
- \_\_\_\_\_ Barefoot, Aldos C., and Stecher, Donald A.  
1951. Quality control in lumber manufacture. 1951 Forest Prod. Res.  
Soc. Annu. Meet. Proc. 5: 26-31.
- Betts Harold  
1969. Extra-thin saws increase lumber yield. Wood & Wood Prod.  
79(8): 29-30.
- Bulgrin, Erwin H., and Hallock, Hiram  
1963. A guide for the selection and control of study sawmills. USDA  
Forest Serv., Forest Prod. lab. 63-048, 62 pp., illus.
- Calvert, W.W., and Johnston, J.S.  
1967. Test shows lumber, chip recovery higher on band than circular  
saws. North. Logger & Timber Process. 16(5):23-27.
- Compton, Kenneth C.  
1956. Increasing sawmill efficiency. Forest Prod. J. 6(1): 19-27.

- Grantham, J.B.  
 1950. Quality control in sawmill operations as predicted in class 'A Douglas fir mills. 1950 Forest Prod. Res. Soc. Annu. Meet. Proc. 4: 149-161.
- Hallock, Hiram  
 1962. A mathematical analysis of the effect of kerf width on lumber yield from small logs. USDA Forest Serv., Forest Prod. Lab. Rep. 2254, 22 pp., illus.
- 
1962. New study proves narrower kerf hikes yields on logs under 12 inches. South. Lumberman 205(2561): 172, 176, 178.
- 
1964. Some thoughts on marginal sawmill logs. Forest Prod. J. 14(11): 535-539.
- 
- and Jaeger, Edward  
 1964. Some aspects of sawing accuracy in circular mills. Forest Prod. Lab., U.S. Forest Serv. Res. Note FPL-029, 22 pp., illus.
- Imada, T.F.  
 1960. Some effects of mill type on the sawing of small logs. Can. Dep. Forest, Forest Prod. Lab. can., 7 pp., illus.
- Kreider, Charles M., and Coats, Marvin W.  
 1957. Quality control in the sawmill. Forest Prod. J. 7(12): 444-448
- Malcolm, Fredrick B.  
 1963. Physical and economic characteristics of sawdust and lumber. Soc. Amer. Forest. Proc. 1962: 152-157.
- Rodenbach, Richard C., and Doyle, Howard J.  
 1960. Thickness variation of lumber cut in 1959 by circular mills in North Carolina. Furniture, Plywood & Veneer Counc., N.C. Forest. Assoc., Inc., 9 pp., illus.
- Simmons, Fred C.  
 1960. Up-grading the products of hardwood operations. South. Lumberman 200(2498): 33-34, 36, 40.
- Telford, C.J.  
 1956. Thickness variation of lumber cut by circular mills. South. Lumberman 192(2397): 54, 56.



**SPECIFIC  
GRAVITY  
VALUES**



**SPECIFIC GRAVITY VALUES**

**Hardwoods**

| Species              | Specific gravity <sup>1</sup> | Species             | Specific gravity |
|----------------------|-------------------------------|---------------------|------------------|
| Alder – red          | 0.37                          | Hackberry           | 0.49             |
| Ash – white          | 0.55                          | Hickory – bitternut | 0.60             |
| Aspen                | 0.35                          | – mockernut         | 0.64             |
| Basswood             | 0.32                          | – nutmeg            | 0.56             |
| Beech                | 0.56                          | – pignut            | 0.66             |
| Birch – Alaska white | 0.49                          | – shagbark          | 0.64             |
| – paper              | 0.48                          | – shellbark         | 0.62             |
| – sweet              | 0.60                          | – water             | 0.61             |
| – yellow             | 0.55                          | Holly               | 0.50             |
| Buckeye – yellow     | 0.33                          | Honeylocust         | 0.60             |
| Butternut            | 0.36                          | Locust – black      | 0.66             |
| Catalpa – hardy      | 0.38                          | Magnolia – southern | 0.46             |
| Cherry – black       | 0.47                          | – cucumber          | 0.44             |
| Chestnut – American  | 0.40                          | – evergreen         | 0.46             |
| Cottonwood – eastern | 0.37                          | Maple – bigleaf     | 0.44             |
| – northern           | 0.32                          | – black             | 0.52             |
| – black              |                               | – red               | 0.49             |
| Cucumbertree         | 0.44                          | – silver            | 0.44             |
| Elm American (white) | 0.46                          | – sugar             | 0.56             |
| – rock               | 0.57                          | Oak – black         | 0.56             |
| – slippery           | 0.48                          | – bur               | 0.58             |
| – winged             | 0.60                          | – cherrybark        | 0.61             |
| Gum – black          | 0.46                          | – chestnut          | 0.57             |
| – blue               | 0.62                          | –laurel             | 0.56             |
| – red                | 0.44                          | – live              | 0.81             |
| – tupelo             | 0.46                          | – northern red      | 0.56             |
|                      |                               | – overcup           | 0.57             |
|                      |                               | – pin               | 0.58             |
|                      |                               | – post              | 0.60             |
|                      |                               | – scarlet           | 0.60             |
|                      |                               | – southern red      | 0.52             |
|                      |                               | – swamp chestnut    | 0.60             |
|                      |                               | – swamp white       | 0.64             |

Table continued on next page

**Hardwoods**

| Species              | Specific gravity <sup>1</sup> | Species              | Specific gravity <sup>1</sup> |
|----------------------|-------------------------------|----------------------|-------------------------------|
| – water              | 0.56                          |                      |                               |
| – white              | 0.60                          | Sycamore – American  | 0.46                          |
| – willow             | 0.56                          |                      |                               |
| Pecan                | 0.60                          | Tupelo – black       | 0.46                          |
|                      |                               | – water              | 0.46                          |
| Poplar – balsam      | 0.30                          |                      |                               |
| – yellow             | 0.40                          | Walnut               | 0.51                          |
| Sweetgum             | 0.46                          | Willow – black       | 0.34                          |
| Softwoods            |                               |                      |                               |
| Cedar – Alaska       | 0.42                          | – Jeffrey            | 0.37                          |
| – Atlantic white     | 0.31                          | – limber             | 0.37                          |
| – eastern red        | 0.44                          | – loblolly           | 0.47                          |
| – incense            | 0.35                          | – lodgepole          | 0.38                          |
| – northern white     | 0.29                          | – longleaf           | 0.54                          |
| – Port-Orford        | 0.40                          | – mountain           | 0.49                          |
| – southern red       | 0.42                          | – northern white     | 0.34                          |
| – western red        | 0.31                          | – Norway             | 0.44                          |
|                      |                               | – pinyon             | 0.50                          |
| Cypress – southern   | 0.42                          | – pitch              | 0.45                          |
|                      | 0.45                          | – pond               | 0.50                          |
| Douglas-fir – coast  | 0.40                          | – ponderosa          | 0.38                          |
| – Rocky Mt.          |                               | – red                | 0.44                          |
|                      |                               | – sand               | 0.45                          |
| Fir – alpine         | 0.31                          | – shortleaf          | 0.46                          |
| – balsam             | 0.34                          | – slash              | 0.56                          |
| – California red     | 0.37                          | – sugar              | 0.35                          |
| – grand              | 0.37                          | – western white      | 0.36                          |
| – lowland white      | 0.37                          |                      |                               |
| – noble              | 0.35                          |                      |                               |
| – silver             | 0.35                          | Redwood – old growth | 0.38                          |
| – white              | 0.35                          |                      |                               |
| Hemlock – eastern    | 0.38                          | Spruce – black       | 0.38                          |
| – mountain           | 0.43                          | – Englemann          | 0.32                          |
| – western            | 0.38                          | – red                | 0.38                          |
| Larch – western      | 0.51                          | – sitka              | 0.37                          |
|                      |                               | – white              | 0.37                          |
| Pine – eastern white | 0.34                          |                      |                               |
| – jack               | 0.40                          | Tamarack             | 0.49                          |

<sup>1</sup> All specific gravity values are based upon oven-dry weight and green volume.



**STANDARD  
SAW GAGES**

STANDARD SAW GAGES

| Gage<br>(Birmingham) | Fraction<br>Inch      | Thousandths<br>Inch | Millimeters |
|----------------------|-----------------------|---------------------|-------------|
|                      | 1                     | 1.000               | 25.40       |
|                      | $\frac{7}{8}$         | .875                | 22.225      |
|                      | $\frac{3}{4}$         | .750                | 19.05       |
|                      | $\frac{5}{8}$         | .625                | 15.875      |
|                      | $\frac{1}{2}$         | .500                | 12.70       |
|                      | $\frac{15}{32}$       | .4688               | 11.905      |
| 0000                 | $\frac{29}{64}$       | .454                | 11.53       |
| 000                  | $\frac{27}{64}$       | .425                | 10.79       |
| 00                   | $\frac{3}{8}$ Full    | .380                | 9.65        |
| 0                    | $\frac{11}{32}$ Scant | .340                | 8.64        |
| 1                    | $\frac{5}{16}$ Scant  | .300                | 7.62        |
| 2                    | $\frac{9}{32}$        | .284                | 7.21        |
| 3                    | $\frac{1}{4}$ Full    | .259                | 6.57        |
| 4                    | $\frac{15}{64}$       | .238                | 6.04        |
| 5                    | $\frac{7}{32}$        | .220                | 5.59        |
| 6                    | $\frac{13}{64}$       | .203                | 5.18        |
| 7                    | $\frac{3}{16}$ Scant  | .180                | 4.57        |
| 8                    | $\frac{5}{32}$ Full   | .165                | 4.19        |
| 9                    | $\frac{5}{32}$ Scant  | .148                | 3.76        |
| 10                   | $\frac{1}{8}$ Full    | .134                | 3.40        |
| 11                   | $\frac{1}{8}$ Scant   | .120                | 3.05        |
| 12                   | $\frac{7}{64}$        | .109                | 2.77        |
| 13                   | $\frac{3}{32}$        | .095                | 2.41        |
| 14                   | $\frac{5}{64}$ Full   | .083                | 2.10        |
| 15                   | $\frac{5}{64}$ Scant  | .072                | 1.82        |
| 16                   | $\frac{1}{16}$ Full   | .065                | 1.65        |
| 17                   | $\frac{1}{16}$ Scant  | .058                | 1.47        |
| 18                   | $\frac{3}{64}$        | .049                | 1.24        |
| 19                   | —                     | .042                | 1.06        |
| 20                   | —                     | .035                | .89         |
| 21                   | $\frac{1}{32}$        | .032                | .81         |
| 22                   | —                     | .028                | .71         |
| 23                   | —                     | .025                | .64         |
| 24                   | —                     | .022                | .56         |
| 25                   | —                     | .020                | .51         |
| 26                   | —                     | .018                | .46         |
| 27                   | $\frac{1}{64}$        | .016                | .41         |
| 28                   | —                     | .014                | .36         |
| 29                   | —                     | .013                | .33         |
| 30                   | —                     | .012                | .30         |